

Laparoscopic Hand Instruments

Standard and Monopolar Hand Instruments	341
HICURA Standard and Monopolar Hand Instruments	341
HICURA 5 mm Grasping Forceps	343
HICURA 5 mm Dissection Forceps	353
HICURA 5 mm Biopsy Forceps	357
HICURA 5 mm Monopolar Scissors	359
HICURA Standard and Monopolar, Accessories and Spare Parts	361
HiQ+ 5 mm Grasping Forceps	363
HiQ+ 5 mm Dissection Forceps	371
HiQ+ 5 mm Biopsy Forceps	375
HiQ+ 5 mm Monopolar Scissors	377
HiQ+ 10 mm Hand Instruments	379
HiQ+ Accessories and Spare Parts	383
Bipolar Hand Instruments	385
HICURA Bipolar Hand Instruments	385
HICURA Bipolar Grasping Forceps	387
HICURA Bipolar Dissection Forceps	389
HICURA Bipolar Accessories and Spare Parts	391
HiQ+ Bipolar Bipolar Hand Instruments	393
HiQ+ Bipolar Grasping Forceps	395
HiQ+ Bipolar Dissection Forceps	397
HiQ+ Bipolar Accessories and Spare Parts	399
Suture	401
HiQ+ Needle Holders	401
HICURA Suture, Clip Application	405
Surgical Instruments	407
HiQ+ Suction and Irrigation	407
HiQ+ Suction and Irrigation System Chart	410
Lavage Instruments for Lavage	411
HiQ+ HF Electrodes	413
Electrosurgical High Frequency Devices	415
Electrosurgical High Frequency Devices Standard Mono- and Bipolar Energy	415

HICURA

Standard and Monopolar Hand Instruments



red dot award 2014
winner





- Different hands – different needs
HICURA offers two different handle sizes: size M for small to medium hands, and size L for medium to large hands. HICURA handles are designed to enhance usability and user comfort during laparoscopy. Depending on preferences and the field of application, handles with ratchet, deactivatable ratchet, or no ratchet are available.



- Adapted jaws mechanism
The two dedicated joint mechanisms (CAM and SL) give the surgeon adapted tissue control during grasping and dissection. Optimized tissue manipulation with the CAM grasping mechanism and the SL dissection mechanism: The CAM mechanism provides higher grasping forces and is therefore designed for firm grasping, whereas the SL mechanism is designed for optimized dissection because the jaws open at a wider angle.



- Assembly and disassembly have never been easier – just click it! HICURA's modular system allows intuitive and easy assembly in just three steps. Acoustic feedback confirms that the instrument has been correctly assembled. Furthermore, there's no need to assemble HICURA instruments in the OR because there's the option of steam sterilization of 250 mm and 330 mm HICURA versions in their assembled state.



- Rotation knob
The new design of the rotation knob allows easy and precise rotation of the jaws insert. Rotation with low resistance when the jaws are open, retarded rotation when tissue is firmly grasped.

HICURA

5 mm Grasping Forceps



- Atraumatic forceps:
Multipurpose grasping forceps for all laparoscopic applications
- Claw type forceps:
For example, for recovery of gall bladder, myoma, etc.
- Flat forceps:
Multipurpose fenestrated grasping forceps for all laparoscopic applications
- Forceps with big lumen:
Atraumatic grasping forceps for delicate tissue (e.g. bowel, tubes)

Atraumatic Forceps

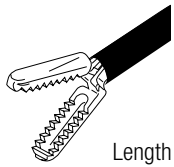
S
250mmM
330mmL
430mm

Length of jaws: 16 mm

Components

WA69336M	Jaws insert "HICURA", 5 x 330, atraumatic, monopolar
WA69336S	Jaws insert "HICURA", 5 x 250, atraumatic, monopolar
WA69336L	Jaws insert "HICURA", 5 x 430, atraumatic, monopolar

Claw Type Forceps

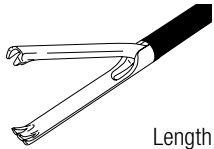
S
250mmM
330mmL
430mm

Length of jaws: 28 mm

Components

WA69344M	Jaws insert "HICURA", 5 x 330, claw type, monopolar
WA69344S	Jaws insert "HICURA", 5 x 250, claw type, monopolar
WA69344L	Jaws insert "HICURA", 5 x 430, claw type, monopolar

Flat Forceps

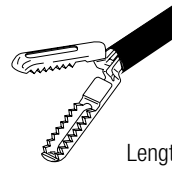
S
250mmM
330mmL
430mm

Length of jaws: 19 mm

Components

WA69338M	Jaws insert "HICURA", 5 x 330, flat, monopolar
WA69338S	Jaws insert "HICURA", 5 x 250, flat, monopolar
WA69338L	Jaws insert "HICURA", 5 x 430, flat, monopolar

Forceps with Big Lumen

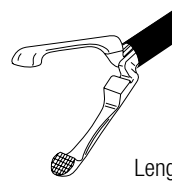
S
250mmM
330mmL
430mm

Length of jaws: 21 mm

Components

WA69340M	Jaws insert "HICURA", 5 x 330, with big lumen, monopolar
WA69340S	Jaws insert "HICURA", 5 x 250, with big lumen, monopolar
WA69340L	Jaws insert "HICURA", 5 x 430, with big lumen, monopolar

HICURA

5 mm Grasping Forceps (cont.)

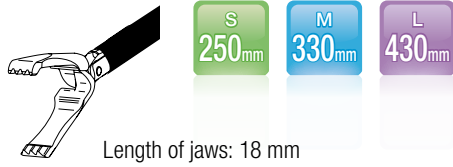

- Manhes forceps:
Precise fixation and manipulation of fragile tissue
- Crocodile type forceps:
For strong and tight fixation of tissue
(e.g. stomach, gall bladder)
- Wave type forceps:
Dedicated grasping forceps for bowel and fragile tissue
- Johann forceps:
Atraumatic fenestrated multipurpose grasping
forceps with large jaws and good visibility

Manhes Forceps

Components

WA69342M	Jaws insert "HICURA", 5 x 330, Manhes, monopolar
WA69342S	Jaws insert "HICURA", 5 x 250, Manhes, monopolar
WA69342L	Jaws insert "HICURA", 5 x 430, Manhes, monopolar

Wave Type Grasping Forceps

Components

WA69334M	Jaws insert "HICURA", 5 x 330, wave type, monopolar
WA69334S	Jaws insert "HICURA", 5 x 250, wave type, monopolar
WA69334L	Jaws insert "HICURA", 5 x 430, wave type, monopolar

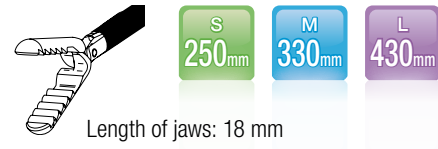
Crocodile Type Forceps

Components

WA69346M	Jaws insert "HICURA", 5 x 330, crocodile type, monopolar
WA69346S	Jaws insert "HICURA", 5 x 250, crocodile type, monopolar
WA69346L	Jaws insert "HICURA", 5 x 430, crocodile type, monopolar

Johann Forceps

Components

WA69310M	Jaws insert "HICURA", 5 x 330, Johann, monopolar
WA69310S	Jaws insert "HICURA", 5 x 250, Johann, monopolar
WA69310L	Jaws insert "HICURA", 5 x 430, Johann, monopolar

HICURA

5 mm Grasping Forceps (cont.)



- Babcock forceps:
Widest inner lumen of all the 5 mm HICURA hand instruments; “paddle” design for maximum grasping performance without damage to soft tissue (e.g. colon)



- Long Johann forceps:
Longest jaws in the 5 mm line of HICURA hand instruments for atraumatic grasping of larger organs (e.g. colon)



- Johann single-action forceps:
The single-action mechanism offers improved handling in restricted operation areas and enables atraumatic and firm grasping of soft tissue (e.g. colon)

Babcock Forceps

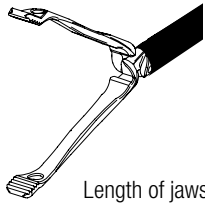

Length of jaws: 31 mm

Components

WA69316M	Jaws insert "HICURA", 5 x 330, Babcock, monopolar
WA69316S	Jaws insert "HICURA", 5 x 250, Babcock, monopolar
WA69316L	Jaws insert "HICURA", 5 x 430, Babcock, monopolar

Long Johann Forceps

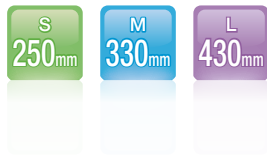
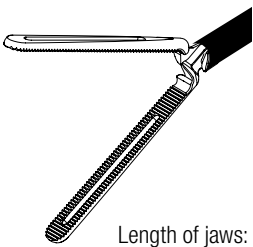

Length of jaws: 40 mm

Components

WA69314M	Jaws insert "HICURA", 5 x 330, Johann long, monopolar
WA69314S	Jaws insert "HICURA", 5 x 250, Johann long, monopolar
WA69314L	Jaws insert "HICURA", 5 x 430, Johann long, monopolar

Johann Single-Action Forceps

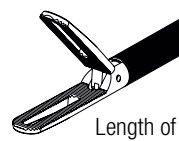

Length of jaws: 24 mm

Components

WA69312M	Jaws insert "HICURA", 5 x 330, Johann, single action, monopolar
WA69312S	Jaws insert "HICURA", 5 x 250, Johann, single action, monopolar
WA69312L	Jaws insert "HICURA", 5 x 430, Johann, single action, monopolar

HICURA

5 mm Grasping Forceps (cont.)

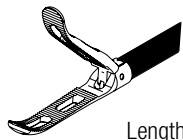

- CroceOlmi forceps:
Special jaws design allows grasping and refixation of tissue from the hernia sac, together with bowel manipulation
- DeBakey forceps:
Fine-toothed jaws design and long jaws allow atraumatic grasping of the bowel and other delicate tissue
- Forceps with lumen:
Good atraumatic grip due to inner lumen and short length. The lumen creates a tweezer effect. Useful in endometriosis treatment
- Clinching forceps:
Special jaws design allows atraumatic firm grasping of the gall bladder and other slippery tissue. Mandatory for cholecystectomy

CroceOlmi Forceps

Length of jaws: 29 mm

Components

WA69320M	Jaws insert "HICURA", 5 x 330, CroceOlmi, monopolar
WA69320S	Jaws insert "HICURA", 5 x 250, CroceOlmi, monopolar
WA69320L	Jaws insert "HICURA", 5 x 430, CroceOlmi, monopolar

Forceps with Lumen

Length of jaws: 16 mm

Components

WA69330M	Jaws insert "HICURA", 5 x 330, with lumen, monopolar
WA69330S	Jaws insert "HICURA", 5 x 250, with lumen, monopolar
WA69330L	Jaws insert "HICURA", 5 x 430, with lumen, monopolar

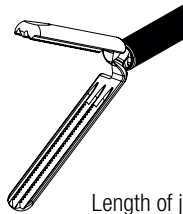
DeBakey Forceps

Length of jaws: 31 mm

Components

WA69318M	Jaws insert "HICURA", 5 x 330, DeBakey, monopolar
WA69318S	Jaws insert "HICURA", 5 x 250, DeBakey, monopolar
WA69318L	Jaws insert "HICURA", 5 x 430, DeBakey, monopolar

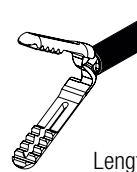
Clinching Forceps

Length of jaws: 26 mm

Components

WA69332M	Jaws insert "HICURA", 5 x 330, Clinching, monopolar
WA69332S	Jaws insert "HICURA", 5 x 250, Clinching, monopolar
WA69332L	Jaws insert "HICURA", 5 x 430, Clinching, monopolar

HICURA

5 mm Grasping Forceps (cont.)

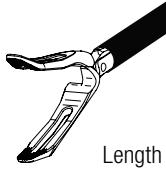

- Precision forceps:
Grasping forceps for very precise grasping performance
- Long Precision forceps:
Longer branch lengths improve overview and handling
- Flat forceps for thoracic surgery:
For atraumatic manipulation of tissue
- Forceps for thoracic surgery:
For atraumatic manipulation of tissue

Precision Forceps

M
330_{mm}

Length of jaws: 24 mm

Components

WA69322M Jaws insert "HICURA", 5 x 330, Precision, monopolar

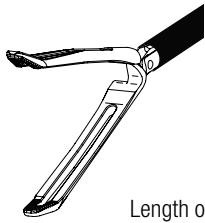
Long Precision Forceps

M
330_{mm}

Length of jaws: 36 mm

Components

WA69324M Jaws insert "HICURA",
5 x 330, long Precision, monopolar

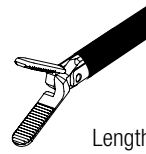
Flat Forceps for Thoracic Surgery

S
250_{mm}

Length of jaws: 14 mm

Components

WA69326S Jaws insert "HICURA",
5 x 250, flat, for thoracic surgery, monopolar

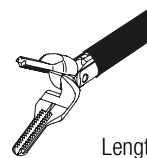
Forceps for Thoracic Surgery

S
250_{mm}

Length of jaws: 16 mm

Components

WA69328S Jaws insert "HICURA",
5 x 250, for thoracic surgery, monopolar

HICURA

5 mm Dissection Forceps

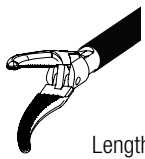

- Maryland forceps:
Multipurpose curved dissection forceps with cross-cut surface for strong grasping and all laparoscopic applications
- Maryland long forceps:
Longer branch length improves overview and handling
- Precision forceps:
For very precise dissection

Maryland ForcepsS
250_{mm}M
330_{mm}L
430_{mm}

Length of jaws: 17 mm

Components

WA69350M	Jaws insert "HICURA", 5 x 330, Maryland, monopolar
WA69350S	Jaws insert "HICURA", 5 x 250, Maryland, monopolar
WA69350L	Jaws insert "HICURA", 5 x 430, Maryland, monopolar

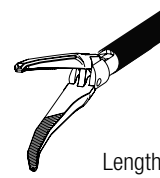
Precision ForcepsM
330_{mm}

Length of jaws: 25 mm

Components

WA69354M	Jaws insert "HICURA", 5 x 330, Precision, monopolar
-----------------	--

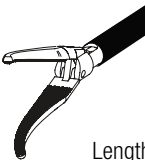
Maryland Long ForcepsS
250_{mm}M
330_{mm}L
430_{mm}

Length of jaws: 21 mm

Components

WA69352M	Jaws insert "HICURA", 5 x 330, Maryland long, monopolar
WA69352S	Jaws insert "HICURA", 5 x 250, Maryland long, monopolar
WA69352L	Jaws insert "HICURA", 5 x 430, Maryland long, monopolar

HICURA

5 mm Dissection Forceps (cont.)



- Tear drop dissector:
To ensure atraumatic blunt dissection of fragile tissue



- Maryland straight forceps:
For delicate dissection and needle holder assistance



- Maryland 90° angled forceps:
For blood vessel dissection

Tear Drop Forceps

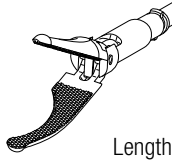

M
330mm

Length of jaws: 16 mm

Components

WA69362M Jaws insert "HICURA",
5 x 330, Tear drop forceps,
monopolar

Maryland Straight Forceps

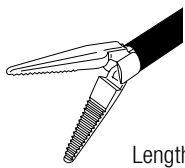

S
250mm

M
330mm

L
430mm

Length of jaws: 15 mm

Components

WA69356M Jaws insert "HICURA",
5 x 330, Maryland straight,
monopolar

WA69356S Jaws insert "HICURA",
5 x 250, Maryland straight,
monopolar

WA69356L Jaws insert "HICURA",
5 x 430, Maryland straight,
monopolar

Maryland 90° Angled Forceps

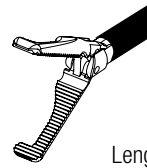

S
250mm

M
330mm

L
430mm

Length of jaws: 18 mm

Components

WA69358M Jaws insert "HICURA",
5 x 330, Maryland 90° angled,
monopolar

WA69358S Jaws insert "HICURA",
5 x 250, Maryland 90° angled,
monopolar

WA69358L Jaws insert "HICURA",
5 x 430, Maryland 90° angled,
monopolar

HICURA

5 mm Biopsy Forceps



- Biopsy forceps with spikes

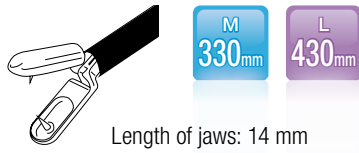

- Severing biopsy forceps

Biopsy Forceps with Spikes

Components

WA69390M Jaws insert "HICURA",
5 x 330, with spike,
monopolar

WA69390L Jaws insert "HICURA",
5 x 430, with spike,
monopolar

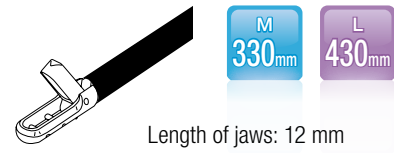
Severing Biopsy Forceps

Components

WA69392M Jaws insert "HICURA",
5 x 330, severing,
monopolar

WA69392L Jaws insert "HICURA",
5 x 430, severing,
monopolar

HICURA

5 mm Monopolar Scissors



- Precision scissors:
For delicate manipulations
in areas with limited space



- Metzenbaum scissors:
Multipurpose scissors for all
laparoscopic applications



- Mini-Metzenbaum scissors:
For precise cutting and preparation



- Hook scissors:
For cutting of sutures



- Straight scissors

Precision Scissors

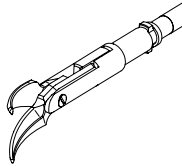
M
330_{mm}

Components

WA69378M Jaws insert "HICURA", 5 x 330, Precision Scissors, monopolar

Metzenbaum Scissors

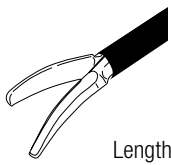
S
250_{mm}M
330_{mm}L
430_{mm}

Length of jaws: 19 mm

Components

WA69370M Jaws insert "HICURA", 5 x 330, Metzenbaum, monopolar

WA69370S Jaws insert "HICURA", 5 x 250, Metzenbaum, monopolar

WA69370L Jaws insert "HICURA", 5 x 430, Metzenbaum, monopolar

Mini-Metzenbaum Scissors

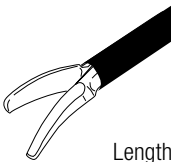
S
250_{mm}M
330_{mm}L
430_{mm}

Length of jaws: 16 mm

Components

WA69372M Jaws insert "HICURA", 5 x 330, Metzenbaum mini, monopolar

WA69372S Jaws insert "HICURA", 5 x 250, Metzenbaum mini, monopolar

WA69372L Jaws insert "HICURA", 5 x 430, Metzenbaum mini, monopolar

Hook Scissors

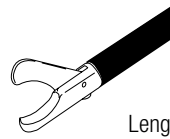
S
250_{mm}M
330_{mm}L
430_{mm}

Length of jaws: 12 mm

Components

WA69376M Jaws insert "HICURA", 5 x 330, hook, monopolar

WA69376S Jaws insert "HICURA", 5 x 250, hook, monopolar

WA69376L Jaws insert "HICURA", 5 x 430, hook, monopolar

Straight Scissors

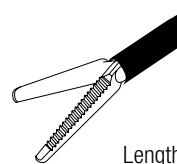
S
250_{mm}M
330_{mm}L
430_{mm}

Length of jaws: 19 mm

Components

WA69374M Jaws insert "HICURA", 5 x 330, straight, monopolar

WA69374S Jaws insert "HICURA", 5 x 250, straight, monopolar

WA69374L Jaws insert "HICURA", 5 x 430, straight, monopolar

HICURA

Standard and Monopolar,
Accessories and Spare Parts

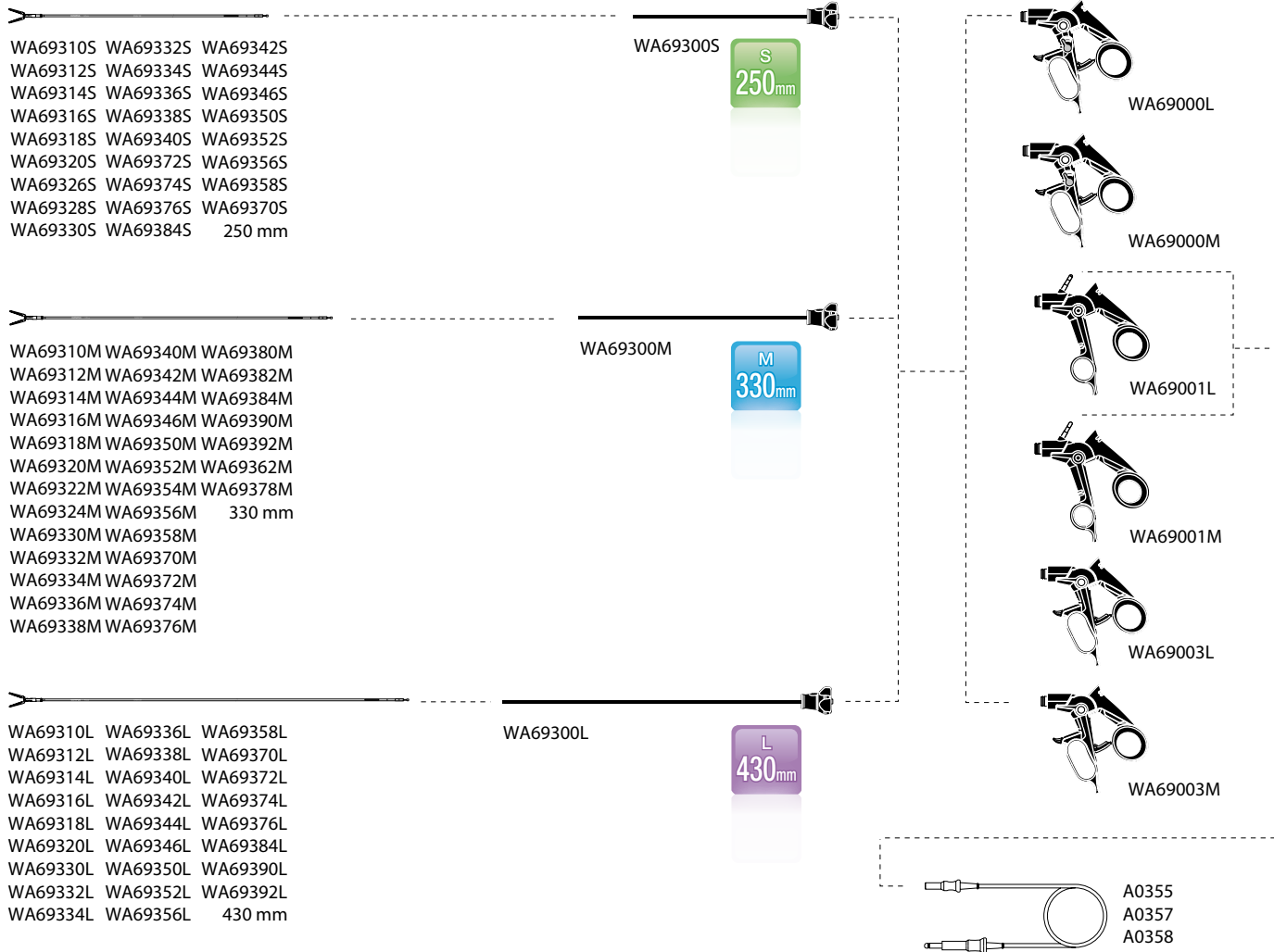

Surgery

HICURA Handles

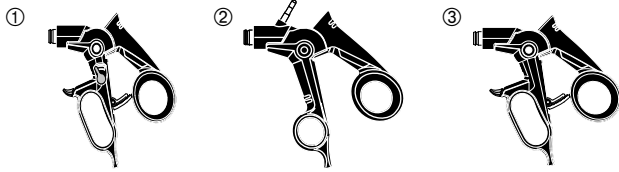

① **WA69000M** Handle "HICURA",
deactivatable ratchet,
size M

WA69000L Handle "HICURA",
deactivatable ratchet,
size L

② **WA69001M** Handle "HICURA",
monopolar,
size M

WA69001L Handle "HICURA",
monopolar,
size L

③ **WA69003M** Handle "HICURA",
ratchet,
size M

WA69003L Handle "HICURA",
ratchet,
size L

HF Cables

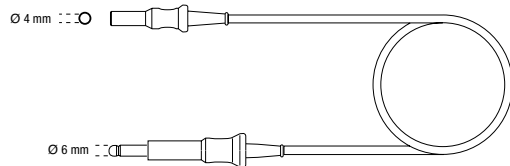

A0358 HF cable, monopolar
Compatible HF units:
▪ ESG-400
▪ ESG-410
▪ Valleylab (new)

A0355 HF cable, monopolar
Compatible HF units:
▪ Valleylab (old)

A0357 HF cable, monopolar
Compatible HF units:
▪ ESG-400
▪ ESG-410
▪ Erbe T series
▪ Berchtold

HICURA Shafts

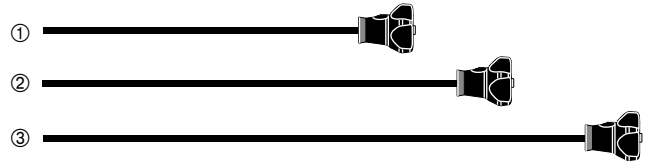

① **WA69300S** Shaft "HICURA",
5 x 250,
monopolar

② **WA69300M** Shaft "HICURA",
5 x 330,
monopolar

③ **WA69300L** Shaft "HICURA",
5 x 430,
monopolar

Instrument Basket System

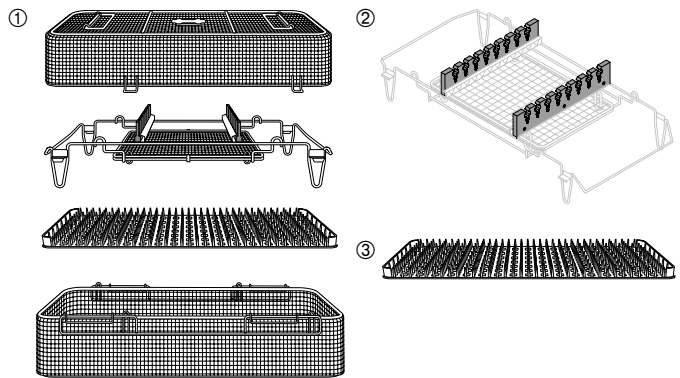

① **WA05956A** Instrument basket system,
for HiQ+, HICURA

② **WA05957A** Spare retainer,
silicone, set, 2 pcs.,
for WA05956A

③ **WA05958A** Spare mat,
nubby, silicone,
for WA05956A

HiQ+

5 mm Grasping Forceps



- Atraumatic grasping forceps:
Multipurpose grasping forceps for all laparoscopic applications
- Claw forceps:
For recoverage of gall bladder, myoma, etc.
- Flat grasping forceps:
Multipurpose fenestrated grasping forceps for all laparoscopic applications
- Grasping forceps with lumen:
Atraumatic grasping forceps for delicate tissue (e.g. bowel, tubes)

Atraumatic Grasping Forceps

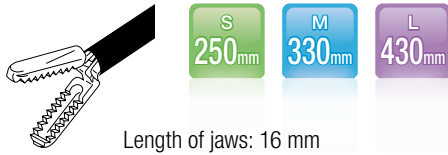

Length of jaws: 16 mm

Components

A64010S	Jaws "HiQ+", 5 x 250 mm, grasping forceps
A64010A	Jaws "HiQ+", 5 x 330 mm, grasping forceps
A64010L	Jaws "HiQ+", 5 x 430 mm, grasping forceps

Claw Forceps

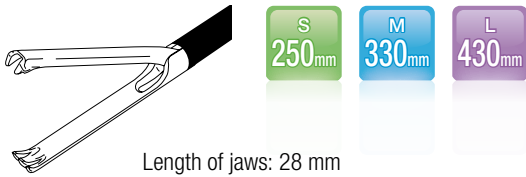

Length of jaws: 28 mm

Components

WA64020S	Jaws "HiQ+", 5 x 250 mm, grasping forceps, claw type
A64020A	Jaws "HiQ+", 5 x 330 mm, claw type
WA64020L	Jaws "HiQ+", 5 x 430 mm, grasping forceps, claw type

Flat Grasping Forceps

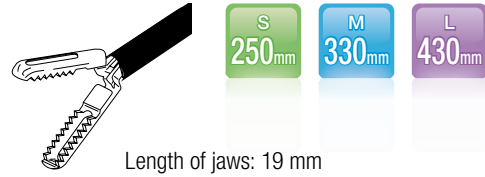

Length of jaws: 19 mm

Components

WA64030S	Jaws "HiQ+", 5 x 250 mm, grasping forceps, flat
A64030A	Jaws "HiQ+", 5 x 330 mm, grasping forceps
WA64030L	Jaws "HiQ+", 5 x 430 mm, grasping forceps, flat

Grasping Forceps with Lumen

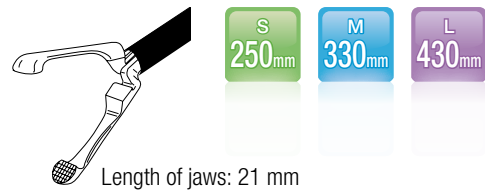

Length of jaws: 21 mm

Components

WA64040S	Jaws "HiQ+", 5 x 250 mm, grasping forceps, lumen
A64040A	Jaws "HiQ+", 5 x 330 mm, lumen
WA64040L	Jaws "HiQ+", 5 x 430 mm, grasping forceps, lumen

HiQ+

5 mm Grasping Forceps (cont.)



- Manhes forceps:
Precise fixation and manipulation of fragile tissue



- Crocodile forceps:
For strong and tight fixation of tissue
(e.g. stomach, gall bladder)



- Atraumatic wave type forceps:
Dedicated grasping forceps for bowel and fragile tissue

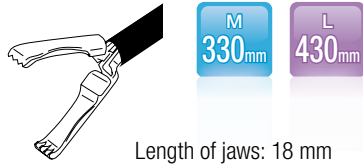

- Johann forceps:
Atraumatic fenestrated multipurpose grasping
forceps with large jaws and good visibility

Manhes Forceps

Components

A64050A	Jaws "HiQ+", 5 x 330 mm, Manhes
WA64050L	Jaws "HiQ+", 5 x 430 mm, grasping forceps, Manhes

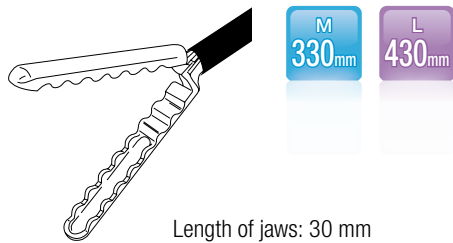
Manhes Forceps

Components

A64080A	Jaws "HiQ+", 5 x 330 mm, wave type
WA64080L	Jaws "HiQ+", 5 x 430 mm, grasping forceps, wave type

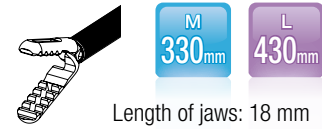
Crocodile Forceps

Components

A64070A	Jaws "HiQ+", 5 x 330 mm, alligator type
WA64070L	Jaws "HiQ+", 5 x 430 mm, grasping forceps, alligator type

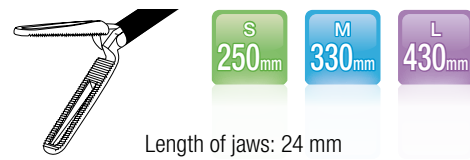
Johann Forceps

Components

A64120S	Jaws "HiQ+", 5 x 250 mm, fine tooth, fenestrated
A64120A	Jaws "HiQ+", 5 x 330 mm, fine tooth, fenestrated
WA64120L	Jaws "HiQ+", 5 x 430 mm, Johann

HiQ+

5 mm Grasping Forceps (cont.)

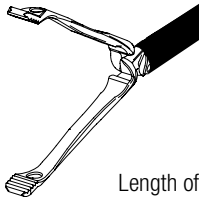

- Babcock forceps:
Widest inner lumen of all 5 mm HiQ+ hand instruments, “paddle” design for maximum grasping performance without damage of soft tissue (e.g. colon)
- Long Johann forceps:
Longest jaws in the 5 mm line of HiQ+ hand instruments for atraumatic grasping of larger organs (e.g. colon)
- Johann single-action forceps:
The single-action mechanism offers improved handling in limited operation areas and allows an atraumatic and firm grasping of soft tissue (e.g. colon)

Babcock ForcepsM
330mmL
430mm

Length of jaws: 31 mm

Components

WA64140A	Jaws "HiQ+", 5 x 330 mm, Babcock
WA64140L	Jaws "HiQ+", 5 x 430 mm, grasping forceps, Babcock

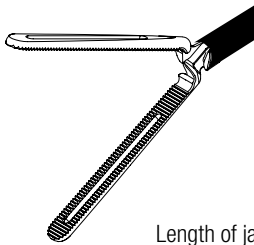
Long Johann ForcepsM
330mmL
430mm

Length of jaws: 40 mm

Components

WA64130A	Jaws "HiQ+", 5 x 330 mm, Johann long
WA64130L	Jaws "HiQ+", 5 x 430 mm, grasping forceps, Johann long

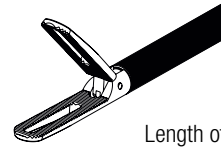
Johann Single-Action ForcepsM
330mmL
430mm

Length of jaws: 24 mm

Components

WA64190A	Jaws "HiQ+", 5 x 330 mm, grasping forceps, Johann, single action
WA64190L	Jaws "HiQ+", 5 x 430 mm, grasping forceps, Johann, single action

HiQ+

5 mm Grasping Forceps (cont.)

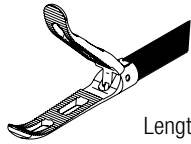

- CroceOlmi forceps:
Allows through a special jaws design the grasping and refixation of the tissue out of the hernia sac and bowel manipulation
- DeBakey forceps:
Fine toothed jaws design and long jaws allow atraumatic grasping of the bowel and other delicate tissue
- Atraumatic forceps with lumen:
Due to inner lumen and short overall length the jaws provide a good atraumatic grip. The lumen creates a tweezer effect. Both the atraumatic grip and the tweezer effect are perfect for perpendicular grasping as needed in the endometriosis treatment
- Clinching forceps:
Allows atraumatic, firm grasping of the gall bladder and other slippery tissue through its special tooth design. Mandatory jaws for cholecystectomy

CroceOlmi Grasping Forceps

M
330mm

L
430mm

Length of jaws: 29 mm

Components

WA64150A Jaws "HiQ+", 5 x 330 mm, grasping forceps, CroceOlmi

WA64150L Jaws "HiQ+", 5 x 430 mm, grasping forceps, CroceOlmi

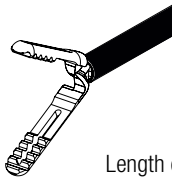
Clinching Forceps

M
330mm

Length of jaws: 26 mm

Components

WA64180A Jaws "HiQ+", 5 x 330 mm, grasping forceps, Clinching

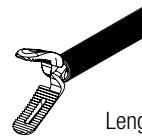
Atraumatic Forceps with Lumen

M
330mm

Length of jaws: 16 mm

Components

WA64170A Jaws "HiQ+", 5 x 330 mm, grasping forceps, atraumatic, lumen

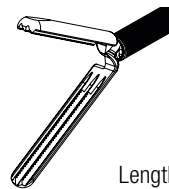
DeBakey Grasping Forceps

M
330mm

L
430mm

Length of jaws: 29 mm

Components

WA64160A Jaws "HiQ+", 5 x 330 mm, grasping forceps, DeBakey

WA64160L Jaws "HiQ+", 5 x 430 mm, grasping forceps, DeBakey

HiQ+

5 mm Dissection Forceps



- Maryland forceps:
Multipurpose curved dissection forceps
for all laparoscopic applications



- Short Maryland forceps:
For precise dissection and needle holder assistance



- Maryland cross tooth:
The cross tooth surface design allows
stronger grasping performance



- Fine Maryland cross tooth:
Longer branch length improves the overview
and handling. The cross tooth surface
allows stronger grasping performance

Maryland Forceps

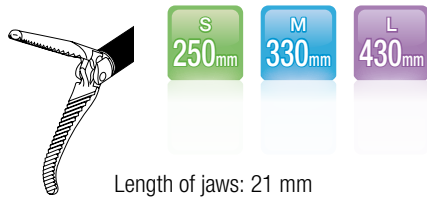

Length of jaws: 21 mm

Components

A64320S	Jaws "HiQ+", 5 x 250 mm, dissection forceps, Maryland
A64320A	Jaws "HiQ+", 5 x 330 mm, dissection forceps, Maryland
A64320L	Jaws "HiQ+", 5 x 430 mm, dissection forceps, Maryland

Short Maryland Forceps

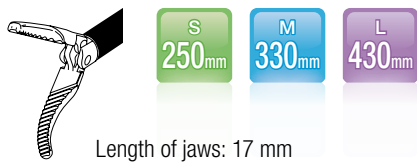

Length of jaws: 17 mm

Components

WA64340S	Jaws "HiQ+", 5 x 250 mm, dissection forceps, Maryland, short
A64340A	Jaws "HiQ+", 5 x 330 mm, dissection forceps, Maryland, short
WA64340L	Jaws "HiQ+", 5 x 430 mm, dissection forceps, Maryland, short

Maryland Forceps with Cross Tooth Pattern



Length of jaws: 17 mm

Components

WA64350S	Jaws "HiQ+", 5 x 250 mm, dissection forceps, Maryland, cross tooth pattern
WA64350A	Jaws "HiQ+", 5 x 330 mm, Dissection forceps, Maryland, cross tooth pattern
WA64350L	Jaws "HiQ+", 5 x 430 mm, dissection forceps, Maryland, cross tooth pattern

Fine Maryland Forceps with Cross Tooth Pattern

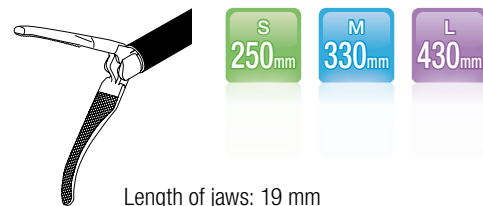

Length of jaws: 19 mm

Components

WA64370S	Jaws "HiQ+", 5 x 250 mm, dissection forceps, Maryland fine, cross tooth pattern
WA64370A	Jaws "HiQ+", 5 x 330 mm, dissection forceps, Maryland fine, cross tooth pattern
WA64370L	Jaws "HiQ+", 5 x 430 mm, dissection forceps, Maryland fine, cross tooth pattern

HiQ+

5 mm Dissection Forceps (cont.)



- Straight dissection forceps:
For delicate dissection and needle holder assistance

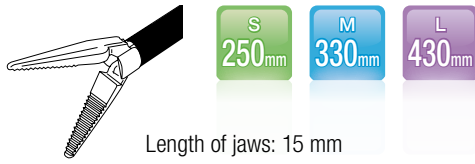

- Right angle dissector:
For blood vessel dissection

Dissection Forceps

Components

A64310S	Jaws "HiQ+", 5 x 250 mm, dissection forceps, straight
A64310A	Jaws "HiQ+", 5 x 330 mm, dissection forceps, straight
WA64310L	Jaws "HiQ+", 5 x 430 mm, dissection forceps, straight

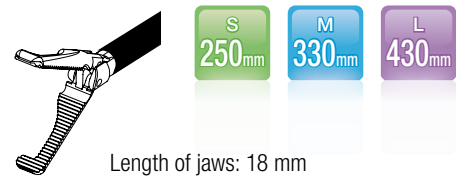
Right Angle Dissection Forceps

Components

WA64330S	Jaws "HiQ+", 5 x 250 mm, dissection forceps, 90° angled
WA64330A	Jaws "HiQ+", 5 x 330 mm, 90° angled
WA64330L	Jaws "HiQ+", 5 x 430 mm, dissection forceps, 90° angled

HiQ+

5 mm Biopsy Forceps



- Biopsy forceps with spike



- Severing biopsy forceps

Biopsy Forceps

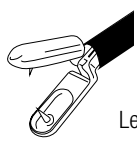
S
250mmM
330mmL
430mm

Length of jaws: 14 mm

Components

A64610S	Jaws "HiQ+", 5 x 250 mm, biopsy forceps, with spike
A64610A	Jaws "HiQ+", 5 x 330 mm, with spike, biopsy forceps
A64610L	Jaws "HiQ+", 5 x 430 mm, biopsy forceps, with spike

Biopsy Forceps

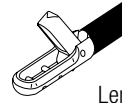
M
330mmL
430mm

Length of jaws: 12 mm

Components

A64620A	Jaws "HiQ+", 5 x 330 mm, biopsy forceps, severing
WA64620L	Jaws "HiQ+", 5 x 430 mm, biopsy forceps, severing

HiQ+

5 mm Monopolar Scissors



- Metzenbaum:
Multipurpose scissors for all laparoscopic applications



- Mini-Metzenbaum:
For precise cutting and preparation



- Hook scissors:
For cutting of sutures



- Straight scissors

Metzenbaum Scissors



Length of jaws: 19 mm

Components

A64810S	Jaws "HiQ+", 5 x 250 mm, scissors, Metzenbaum
A64810A	Jaws "HiQ+", 5 x 330 mm, scissors, Metzenbaum
A64810L	Jaws "HiQ+", 5 x 430 mm, scissors, Metzenbaum

Hook Scissors



Length of jaws: 12 mm

Components

A64820S	Jaws "HiQ+", 5 x 250 mm, hook scissors
A64820A	Jaws "HiQ+", 5 x 330 mm, hook scissors
A64820L	Jaws "HiQ+", 5 x 430 mm, hook scissors

Mini-Metzenbaum Scissors

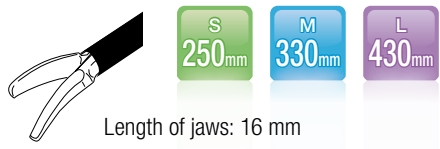

Length of jaws: 16 mm

Components

WA64840S	Jaws "HiQ+", 5 x 250 mm, scissors, Mini-Metzenbaum
A64840A	Jaws "HiQ+", 5 x 330 mm, scissors, Mini-Metzenbaum
WA64840L	Jaws "HiQ+", 5 x 430 mm, scissors, Mini-Metzenbaum

Straight Scissors

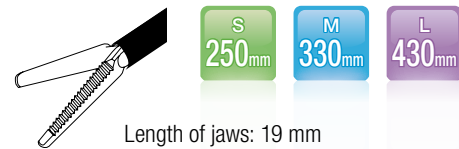

Length of jaws: 19 mm

Components

WA64830S	Jaws "HiQ+", 5 x 250 mm, scissors, straight
A64830A	Jaws "HiQ+", 5 x 330 mm, scissors, straight
WA64830L	Jaws "HiQ+", 5 x 430 mm, scissors, straight

HiQ+

10 mm Hand Instruments

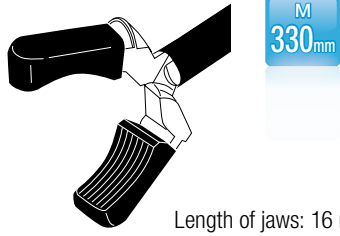

- CBD forceps:
Soft-layered grasping forceps dedicated for manipulation of fragile tissue and flexible telescopes
- Claw forceps:
For recovery of gall bladder, myoma, etc.
- Babcock forceps:
For manipulation of large fragile tissue (e.g. bowel, stomach)
- Babcock-Atrauma forceps:
Widest inner lumen of all 10 mm HiQ+ hand instruments; “paddle” design for maximum grasping performance with no damage of soft tissue (e.g. colon)

CBD Grasping Forceps

Components

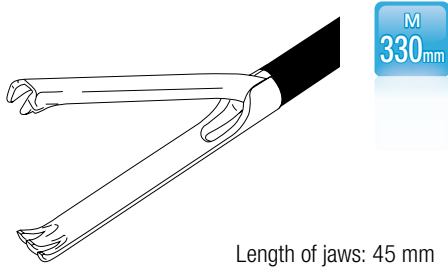
A66070A Jaws "HiQ+", 10 x 330 mm grasping forceps, CBD**Claw Forceps**

Components

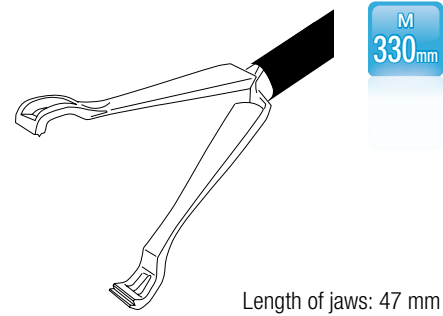
A66020A Jaws "HiQ+", 10 x 330 mm grasping forceps, claw type**Babcock Forceps**

Components

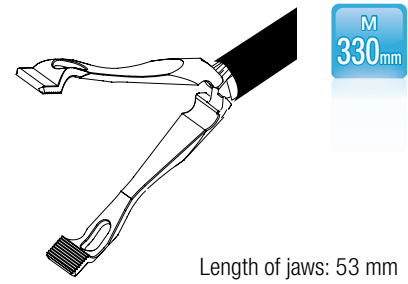
A66050A Jaws "HiQ+", 10 x 330 mm grasping forceps, Babcock**Babcock-Atrauma Forceps**

Components

WA66040A Jaws "HiQ+", 10 x 330 mm grasping forceps, Babcock-Atrauma

HiQ+

10 mm Hand Instruments (cont.)



- Atraumatic wave type forceps:
Dedicated grasping forceps for bowel and fragile tissue



- Maryland forceps:
Multipurpose curved dissection forceps
for all laparoscopic applications

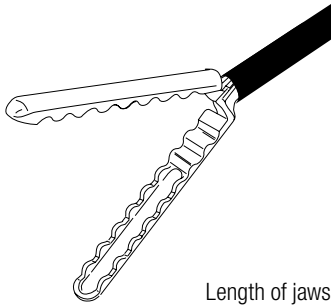

- Short Maryland forceps:
For precise dissection and needle holder assistance

Atraumatic Grasping Forceps

M
330mm

Length of jaws: 42 mm

Components

A66060A Jaws "HiQ+", 10 x 330 mm grasping forceps, wave type

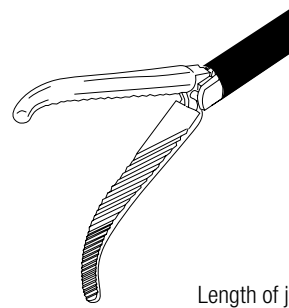
Maryland Forceps

M
330mm

Length of jaws: 30 mm

Components

A66310A Jaws "HiQ+", 10 x 330 mm dissection forceps, Maryland

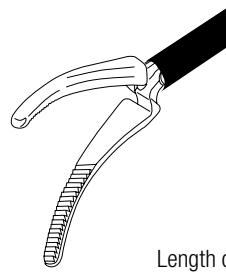
Short Maryland Forceps

M
330mm

Length of jaws: 24 mm

Components

A66320A Jaws "HiQ+", 10 x 330 mm dissection forceps, Maryland, short

HiQ+

Accessories and Spare Parts

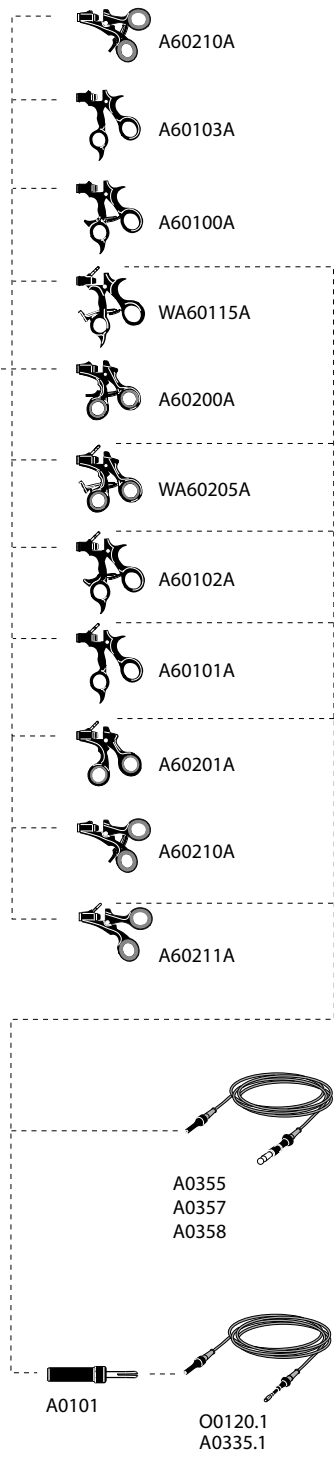
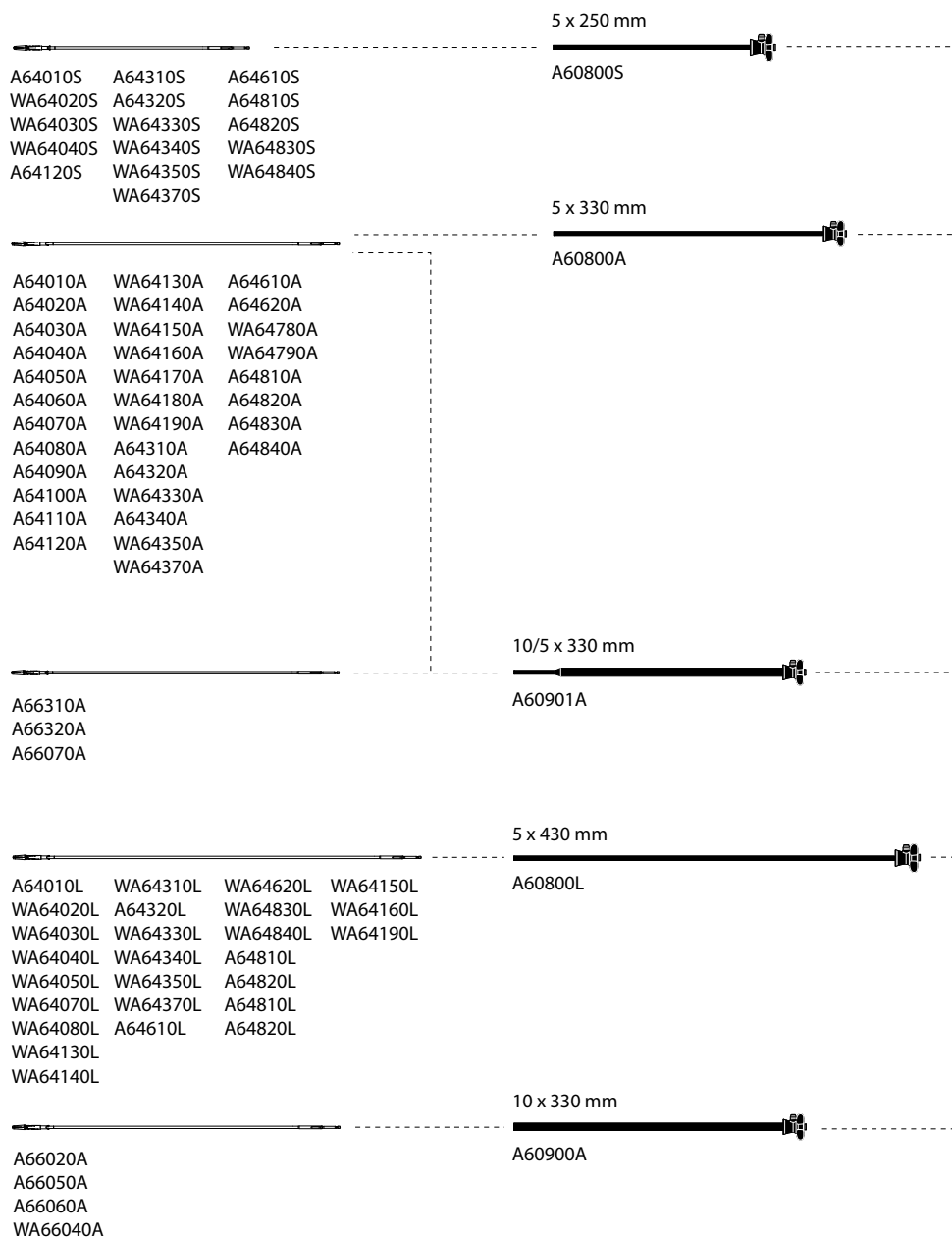

Surgery

HiQ+ Ergo Handles

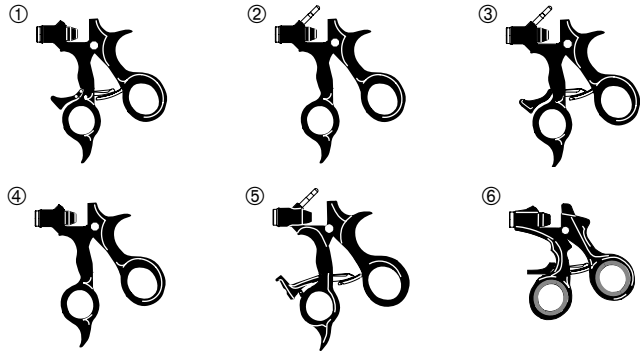

- | | |
|-------------------|--|
| ① A60100A | Handle "HiQ+", Ergo, ratchet |
| ② A60101A | Handle "HiQ+", Ergo, monopolar |
| ③ A60102A | Handle "HiQ+", Ergo, ratchet, monopolar |
| ④ WA60103A | Handle "HiQ+", Ergo |
| ⑤ WA60115A | Handle "HiQ+", Ergo, deactivatable ratchet |
| ⑥ A60200A | Handle "HiQ+", Ergo S, ratchet |

Spare Parts

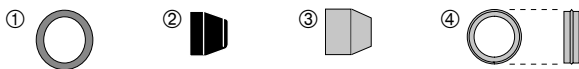

- | | |
|------------------|---|
| ① A0389 | Finger ring, silicone, for HiQ+ |
| ② A03440A | Sealing cap, 2.2 mm, 10 pcs. |
| ③ A03441A | Spare button, for shaft, 10 pcs. |
| ④ A03442A | Spare sealing ring "HiQ+", for shaft, 20 pcs. |

HiQ+ Ergo S Handles

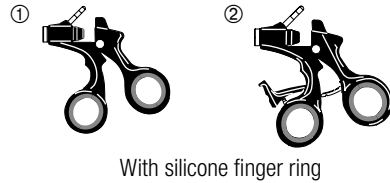

With silicone finger ring

- | | |
|-------------------|--|
| ① A60201A | Handle "HiQ+", Ergo S, monopolar |
| ② WA60205A | Handle "HiQ+", Ergo S, deactivatable ratchet monopolar |

HiQ+ Semi-Inline S Handles

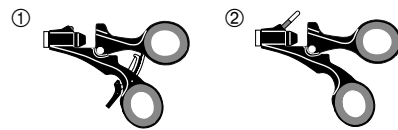

With silicone finger ring

- | | |
|------------------|--|
| ① A60210A | Handle "HiQ+", semi-inline S, with ratchet |
| ② A60211A | Handle "HiQ+", semi-inline S, monopolar |

HiQ+ Shafts

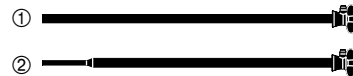

- | | |
|------------------|---|
| ① A60900A | Shaft "HiQ+", 10 x 330 mm, insulated |
| ② A60901A | Shaft "HiQ+", 10 x 330 mm, insulated, tapered |

HF Cables

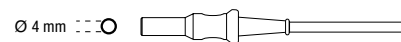

- | | |
|--------------|---|
| A0358 | HF cable, monopolar
Compatible HF units:
<ul style="list-style-type: none"> ESG-400 ESG-410 Valleylab (new) |
| A0355 | HF cable, monopolar
Compatible HF units:
<ul style="list-style-type: none"> Valleylab (old) |
| A0357 | HF cable, monopolar
Compatible HF units:
<ul style="list-style-type: none"> ESG-400 ESG-410 Erbe T series Berchtold |

HICURA

Bipolar Hand Instruments



Surgery



reddot award 2014
winner



- Color coding for clear instrument identification
HICURA bipolar hand instruments are color-coded on the handle and the rotation wheel. The inserts also have a white insulation, so this allows rapid identification of all the bipolar components.



- Excellent jaws insulation
The bipolar jaws are PFA insulated, thus reducing the risk of coagulation failures. The design of HICURA bipolar instruments allows strong grasping and effective coagulation, thereby combining monopolar mechanical strengths with bipolar coagulation.

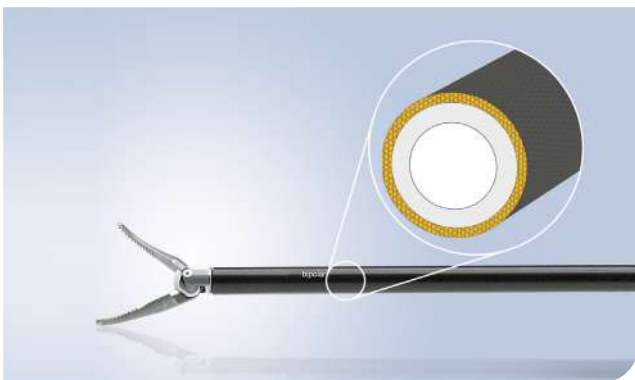

- Safety first!
HICURA shafts are PEEK insulated in order to provide optimized stability, durability and electrical insulation.

HICURA

Bipolar Grasping Forceps

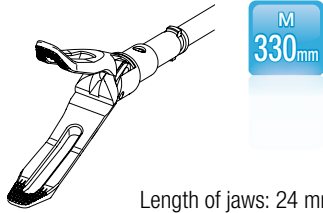

- Precision forceps:
Punctual grasping of thin tissues parts and stable atraumatic grasping of larger tissue parts
- Johann forceps:
Multipurpose grasping forceps for strong grasping and atraumatic dissection and all laparoscopic procedures
- Hirsch forceps:
For precise and atraumatic grasping
- Manhes forceps:
Grasping forceps for myomectomy and cystectomy

Precision Forceps

Components

WA69424M Jaws insert "HICURA", 5 x 330, Precision Forceps, bipolar

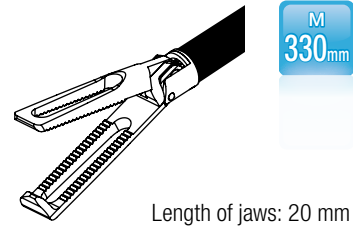
Hirsch Forceps

Components

WA69412M Jaws insert "HICURA", 5 x 330, Hirsch, bipolar

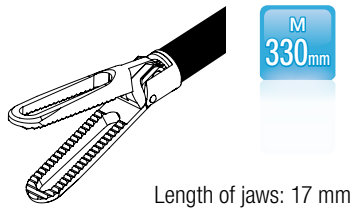
Johann Forceps

Components

WA69410M Jaws insert "HICURA", 5 x 330, Johann, bipolar

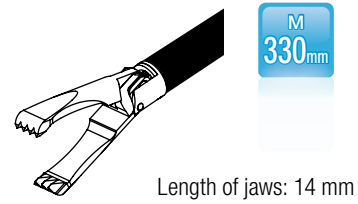
Manhes Forceps

Components

WA69414M Jaws insert "HICURA", 5 x 330, Manhes, bipolar

HICURA

Bipolar Dissection Forceps



- Maryland forceps:
Multipurpose curved dissection forceps
for all laparoscopic procedures



- Fine Maryland forceps:
Improved overview and handling
due to increased branch length



- Straight forceps:
Multipurpose straight dissection forceps
for all laparoscopic procedures

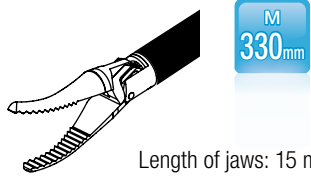

- Tweezers forceps:
For very delicate dissection and coagulation

Maryland Forceps

Components

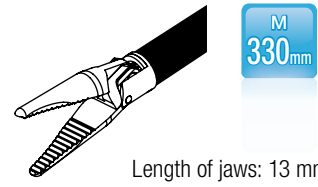
WA69416M Jaws insert "HICURA", 5 x 330, Maryland, bipolar**Straight Forceps**

Components

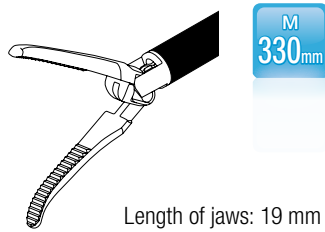
WA69420M Jaws insert "HICURA", 5 x 330, straight, bipolar**Fine Maryland Forceps**

Components

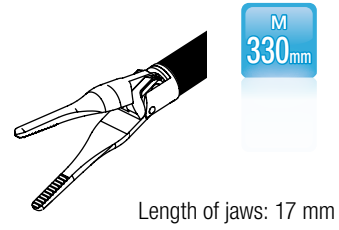
WA69418M Jaws insert "HICURA", 5 x 330, Maryland fine, bipolar**Tweezers Forceps**

Components

WA69422M Jaws insert "HICURA", 5 x 330, tweezers, bipolar

HICURA

Bipolar Accessories and Spare Parts

HICURA Bipolar Handle



WA69002M Handle "HICURA",
bipolar, size M

WA69002L Handle "HICURA",
bipolar, size L

HICURA Bipolar Shaft



WA69400M Shaft "HICURA",
5 x 330, bipolar

Bipolar HF Cable

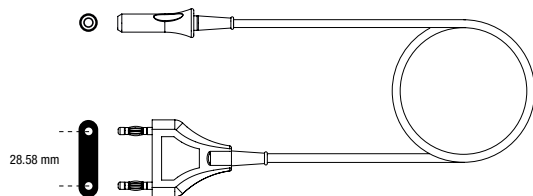

A60003C HF cable, bipolar
Compatible HF units:
▪ ESG-400
▪ ESG-410
▪ Erbe VIO¹
▪ Valleylab HF units

A60001C HF cable, bipolar
Compatible HF units:
▪ ESG-410
▪ Erbe International HF units

Bipolar HF Cable (cont.)

A60002C HF cable, bipolar
Compatible HF units:
▪ Martin

A60000C HF cable, bipolar
Compatible HF units:
▪ ESG-400
▪ ESG-410
▪ HF-300
▪ Erbe HF units¹

¹ Depending on individual connector configuration

Instrument Basket System

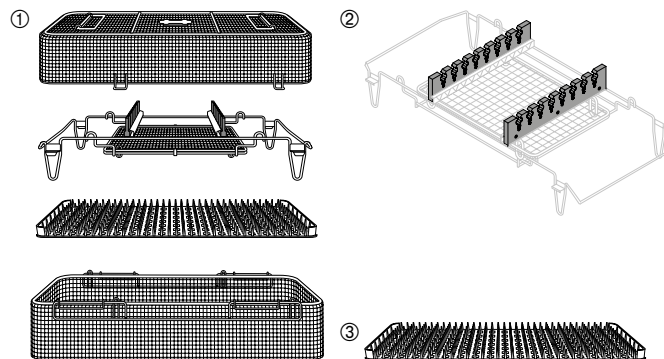

① **WA05956A** Instrument basket system,
for HiQ+, HICURA

② **WA05957A** Spare retainer,
silicone,
set, 2 pcs.,
for WA05956A

③ **WA05958A** Spare mat,
nubby,
silicone,
for WA05956A

System Chart

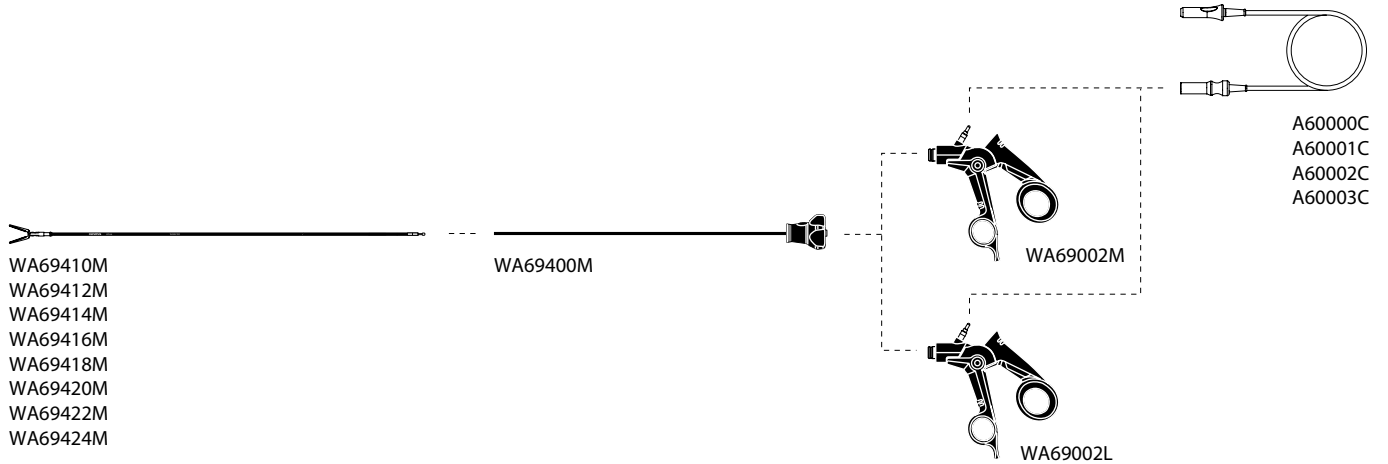

Surgery

HiQ+ Bipolar

Bipolar Hand Instruments



Design
Award
Winner
2009

The Olympus HiQ+ Bipolar series combines the safety benefits of bipolar technology with the precision and tactility of monopolar hand instruments. HiQ+ Bipolar hand instruments are designed for safe and reliable coagulation with the ability of strong grasping and dissecting.

The HiQ+ Bipolar series – a new standard for:

- Gynecology
- General Surgery
- Urology



- **Reliable coagulation:**
HiQ+ Bipolar is designed for reliable coagulation even in challenging situations. Coagulation of small vessels or stopping of sudden bleedings where joints may become covered with blood can be performed smoothly and reliably thanks to the unique joint insulation.



- **Bipolar safety:**
Bipolar instruments are known to be safer than monopolar devices as the electrical current flows directly between the instrument jaws, thus eliminating the need for a patient plate. Better control through focussed current flow within the surgeon's direct field of view. Reduces the risk of unpredictable current flow through the patient's body. Eliminates risk of injuries through malpositioning of the patient plate.



- **Strong grasping and dissection:**
Just as their monopolar counterparts, HiQ+ Bipolar instruments are designed for high performance during grasping and dissecting – but with bipolar safety. HiQ+ Bipolar replaces monopolar instruments even in procedures where strong grasping is required.



- **Easy reprocessing:**
The modular three part design and the “easy click” mechanism of HiQ+ Bipolar instruments allow easy assembly and disassembly. HiQ+ Bipolar instruments are autoclavable to meet high demands regarding sterilisation and disinfection.

HiQ+ Bipolar Grasping Forceps



- Johann forceps:
Multipurpose forceps for strong grasping and atraumatic dissection for all laparoscopic procedures



- Hirsch forceps:
For tubal sterilization and endometriosis treatment

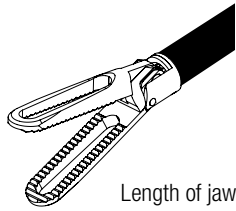

- Manhes forceps:
Grasping forceps for myomectomy and cystectomy

Johann ForcepsM
330_{mm}L
430_{mm}

Length of jaws: 16.5 mm

Components

WA64120C Jaws "HiQ+", bipolar, 5 x 330 mm, grasping forceps, fenestrated

WA64121C Jaws "HiQ+", bipolar, 5 x 430 mm, grasping forceps, fenestrated, long

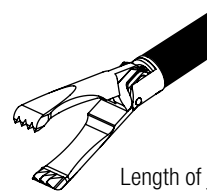
Manhes ForcepsM
330_{mm}L
430_{mm}

Length of jaws: 14 mm

Components

WA64050C Jaws "HiQ+", bipolar, 5 x 330 mm, grasping forceps, Manhes

WA64051C Jaws "HiQ+", bipolar, 5 x 430 mm, grasping forceps, Manhes, long

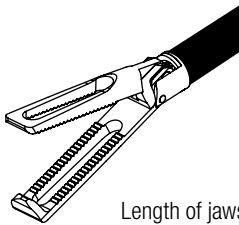
Hirsch ForcepsM
330_{mm}L
430_{mm}

Length of jaws: 19.7 mm

Components

WA64200C Jaws "HiQ+", bipolar, 5 x 330 mm, grasping forceps, Hirsch

WA64201C Jaws "HiQ+", bipolar, 5 x 430 mm, grasping forceps, Hirsch, long

HiQ+ Bipolar Dissection Forceps



- Maryland forceps:
Multipurpose curved dissection forceps for all laparoscopic procedures



- Fine Maryland forceps:
Due to increased branch length the jaws allow improved overview and handling. Suitable for kidney resection and adrenalectomy



- Straight forceps:
Multipurpose straight dissection forceps for all laparoscopic procedures

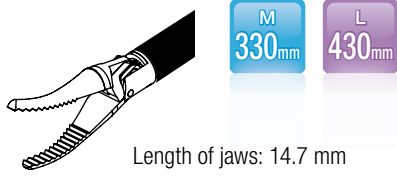

- Tweezers:
For very delicate dissection and coagulation

Maryland Forceps

Length of jaws: 14.7 mm

Components

- WA64320C** Jaws "HiQ+", bipolar, 5 x 330 mm, preparation forceps, Maryland, short
- WA64321C** Jaws "HiQ+", bipolar, 5 x 430 mm, dissection forceps, Maryland, long

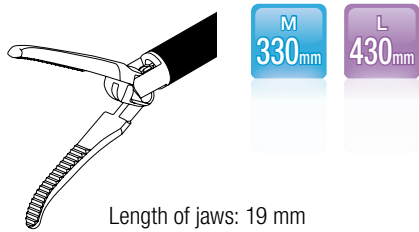
Fine Maryland Forceps

Length of jaws: 19 mm

Components

- WA64360C** Jaws "HiQ+", bipolar, 5 x 330 mm, dissection forceps, Maryland
- WA64361C** Jaws "HiQ+", bipolar, 5 x 430 mm, dissection forceps, Maryland

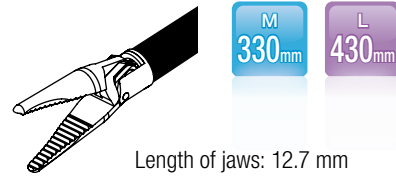
Straight Forceps

Length of jaws: 12.7 mm

Components

- WA64310C** Jaws "HiQ+", bipolar, 5 x 330 mm, preparation forceps, straight
- WA64311C** Jaws "HiQ+", bipolar, 5 x 430 mm, dissection forceps, straight, long

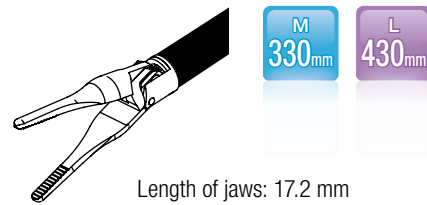
Tweezers

Length of jaws: 17.2 mm

Components

- WA64210C** Jaws "HiQ+", bipolar, 5 x 330 mm, grasping forceps, tweezers
- WA64211C** Jaws "HiQ+", bipolar, 5 x 430 mm, grasping forceps, tweezers, long

HiQ+ Bipolar

Accessories and Spare Parts

HiQ+ Bipolar Ergo Handle



WA60101C Handle "HiQ+", Ergo, bipolar

HiQ+ Bipolar Shaft

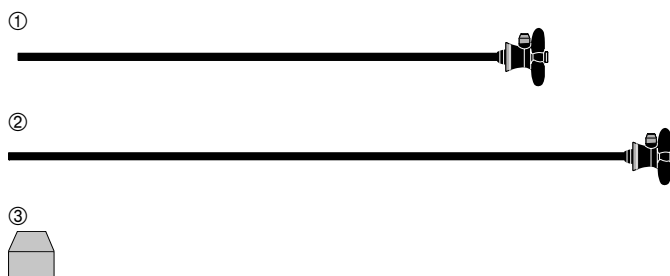

- ① **WA60800C** Shaft "HiQ+", bipolar, 5 x 330 mm, isolated
- ② **WA60801C** Shaft "HiQ+", bipolar, 5 x 430 mm, insulated, long
- ③ **A03441A** Spare-button "HiQ+", for shaft, 10 pcs.

Bipolar HF Cable



- A60003C** HF-cable "HiQ+", bipolar
Compatible HF units:
 - ESG-400
 - ESG-410
 - Erbe VIO¹
 - Valleylab HF units
- A60001C** HF-cable "HiQ+", bipolar
Compatible HF units:
 - ESG-410
 - Erbe International HF units
- A60002C** HF-cable "HiQ+", bipolar
Compatible HF units:
 - Martin
- A60000C** HF-cable "HiQ+", bipolar
Compatible HF units:
 - ESG-400
 - ESG-410
 - HF-300
 - Erbe HF units¹

¹ Depending on individual connector configuration

System Chart

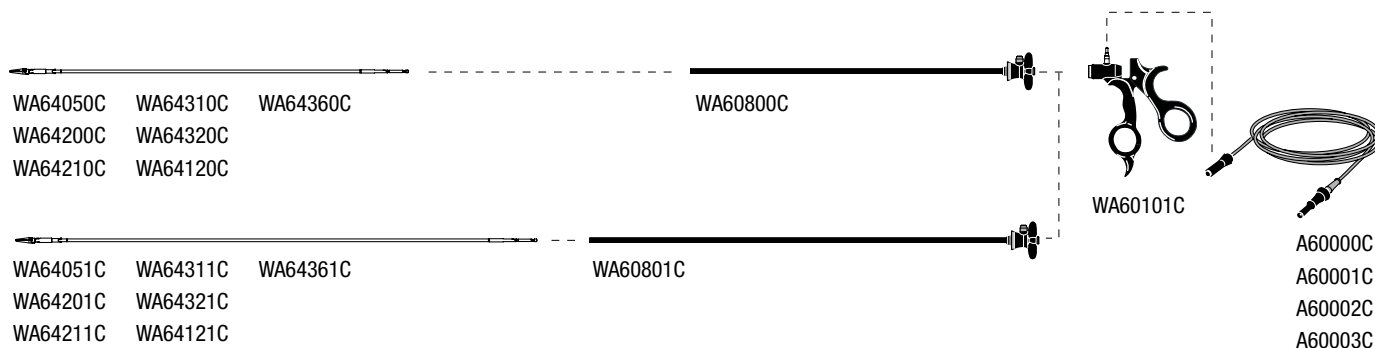

HiQ+

Needle Holders



Baden-Württemberg
International Design Award 2004



GOOD DESIGN
AWARD 2005



Design
Award
Winner
2006



reddot design award
winner 2006



HiQ+ needle holders and knot pushers are a series of instruments designed to satisfy the most exacting requirements when it comes to functionality, ergonomics and up-to-date reprocessing. HiQ+ needle holders are engineered for:

- High grasping strength
- High accuracy to ensure precise and reliable control of the needle
- High durability with hard-metal inlays in the jaws



Exchangeable jaws inserts: The HiQ+ needle holder is available with five interchangeable jaws. The modular design allows for easy assembly, disassembly, and cleaning. All parts are autoclavable.

- Straight needle holder
- Left- and right needle holder
- Dolphin type needle holder
- Assistant needle holder
- Self-alignment needle holder



- The handle of the HiQ+ needle holder has been optimized from an ergonomic perspective. Olympus engineers have worked closely with ergonomics experts to design a handle that will be “an extension of the surgeon's hand”.



- HiQ+ design knot pusher (see page [405](#))

HiQ+

Needle Holders

(cont.)

Straight Needle Holders

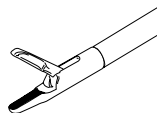

Components

WA64700A	Jaws "HiQ+", 5 x 330 mm, needle holder, straight
WA64700L	Jaws "HiQ+", 5 x 430 mm, needle holder, straight
WA60120A	Handle "HiQ+", inline A, asymmetric, ratchet
WA60120L	Handle "HiQ+", inline A, long, asymmetric, ratchet

Right-Curved Needle Holders

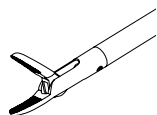

Components

WA64740A	Jaws "HiQ+", 5 x 330 mm, needle holder, right curved
WA64740L	Jaws "HiQ+", 5 x 430 mm, needle holder, right curved
WA60120A	Handle "HiQ+", inline A, asymmetric, ratchet
WA60120L	Handle "HiQ+", inline A, long, asymmetric, ratchet

Dolphin Type Needle Holder

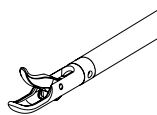

Components

WA64730A	Jaws "HiQ+", 5 x 330 mm, needle holder, dolphin type
WA60120A	Handle "HiQ+", inline A, asymmetric, ratchet

Left-Curved Needle Holders

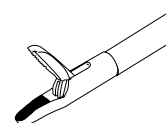

Components

WA64710A	Jaws "HiQ+", 5 x 330 mm, needle holder, curved
WA64710L	Jaws "HiQ+", 5 x 430 mm, needle holder, curved left
WA60120A	Handle "HiQ+", inline A, asymmetric, ratchet
WA60120L	Handle "HiQ+", inline A, long, asymmetric, ratchet

Self-Alignment Needle Holders

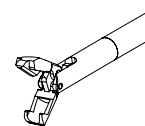

Components

WA64720A	Jaws "HiQ+", 5 x 330 mm, needle holder, self-aligning
WA60120A	Handle "HiQ+", inline A, asymmetric, ratchet

Assistant Needle Holders

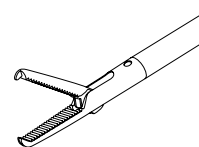

Components

WA64750A	Jaws "HiQ+", 5 x 330 mm, assistant needle holder
WA60120A	Handle "HiQ+", inline A, asymmetric, ratchet

HiQ+ Inline A Handles

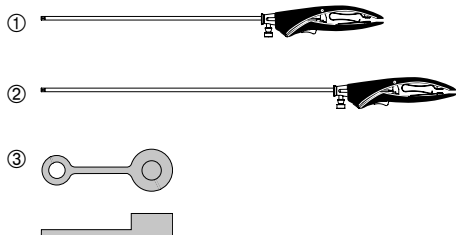

- ① **WA60120A** Handle, with sheath, 330 mm, ratchet
- ② **WA60120L** Handle, with sheath, 430 mm, ratchet
- ③ **A0400** Sealing cap, blue, for Luer-lock, 6 pcs.

System Chart HiQ+ Needle Holders

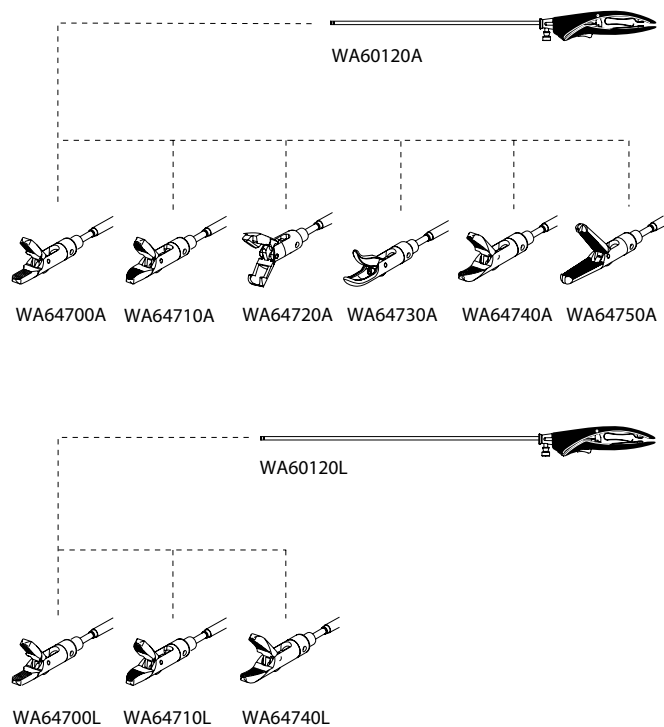

Standard Needle Holders

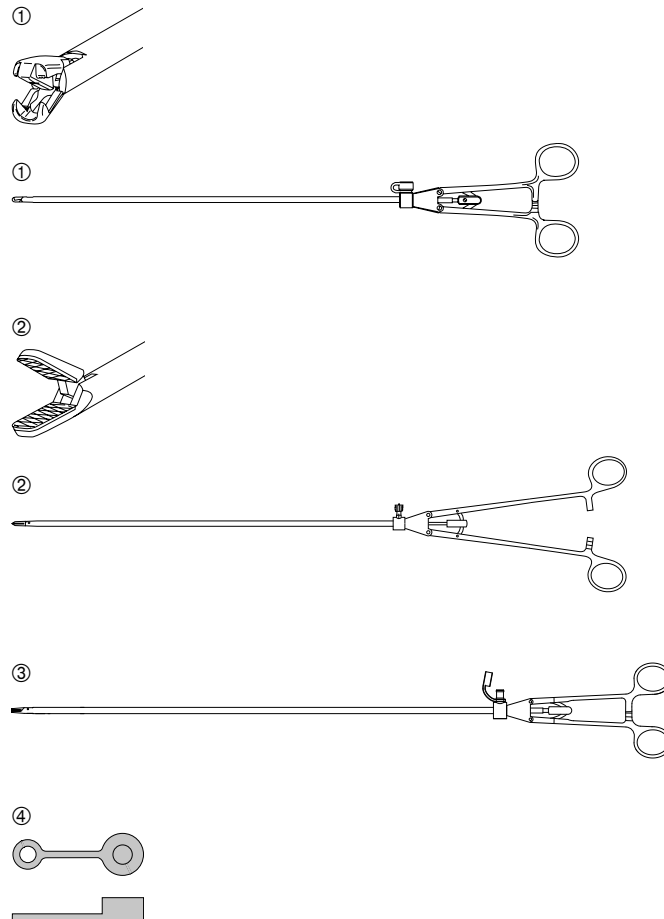

- ① **WA56900A** Grasping forceps, needle holder, with self-alignment, 5 x 300 mm, straight
- ② **A5690** Grasping forceps, needle holder, 5 x 300 mm, inline handle
- A5698** Grasping forceps, needle holder, 5 x 300 mm, curved, inline
- ③ **WA56090L** Grasping forceps, needle holder, 5 x 390 mm, inline handle
- WA56098L** Grasping forceps, needle holder, 5 x 390 mm, curved, inline
- ④ **A0400** Sealing cap, blue, for Luer-lock, 6 pcs.

Surgery

HICURA

Suture, Clip Application

HICURA Knot Pusher

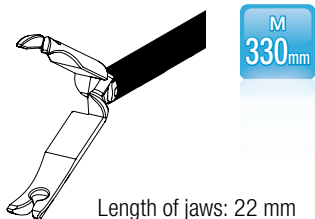

Components

WA69380M Jaws insert "HICURA", 5 x 330, knot pusher

HICURA Roeder Knot Pusher

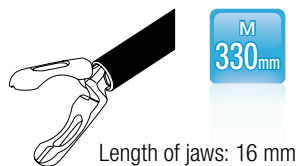

Components

WA69382M Jaws insert "HICURA", 5 x 330, Roeder

HICURA Assistant Needle Holder

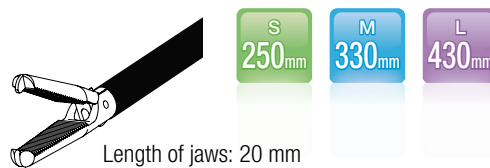

Components

WA69384M Jaws insert "HICURA", 5 x 330, assistant needle holder

WA69384S Jaws insert "HICURA", 5 x 250, assistant needle holder

WA69384L Jaws insert "HICURA", 5 x 430, assistant needle holder

Standard Knot Pusher

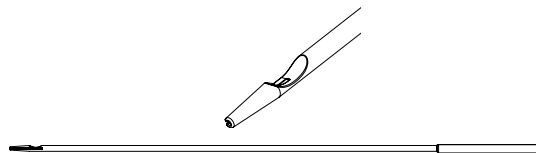

WA56903A Knot pusher,
5 x 330 mm

For accessories and spare parts of HICURA hand instruments, see page 361.

Application of Titanium Clips

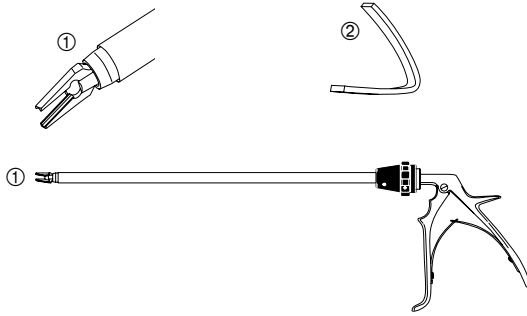

- ① **A56790A** Clip applicator, 10 x 330 mm, for clips medium/large A5635
- Curved
 - Rotatable jaws
 - Can be disassembled for reprocessing.
- ② **A5635** Clip, titanium, medium/large, 18 x 6 pcs.

Use

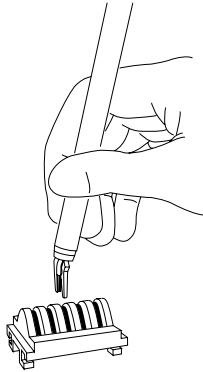

Remove clip from the magazine.

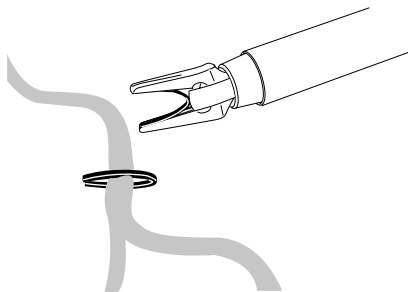

Apply clip.

Fascial Closure

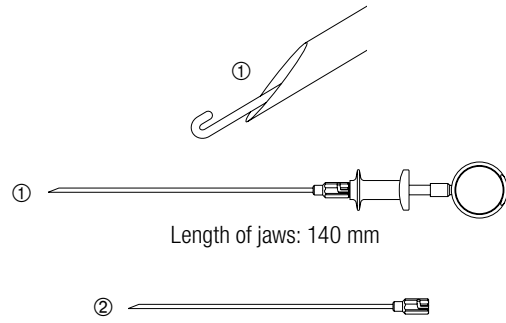

- ① **WA51203A** Needle, for fascial closure
- ② **WA51205A** Spare cannula, for WA51203A

HiQ+

Suction and Irrigation



Surgery



The HiQ+ suction/irrigation system is optimized for streamlined flow throughout every component, from inflow to outflow, thus enabling better passage of immersed blood clots or stones.

The modular system with its range of suction/irrigation tubes offers tailored solutions for a variety of laparoscopic procedures and anatomies.

The HiQ suction/irrigation system combines excellent performance with surgeon-oriented ergonomics and high-end quality.

Customizable system: Olympus offers a wide range of suction/irrigation tubes for its HiQ+ system:

- Diameters of 3, 5 and 10 mm
- Working lengths of 360 and 450 mm
- Multiple tip designs, e.g. for harvesting lost gall bladder stones or aspirating hydrops



Optimized ergonomics – choice of two ergonomically designed handles for differing irrigation needs:

- Active handle with lever-controlled suction/irrigation at your finger tips
- Passive handle for foot switch control in combination with pumps



- Simple reprocessing: The HiQ+ suction/irrigation system has been designed to simplify assembly/disassembly and cleaning. Every component is easily detachable and autoclavable.

HiQ+

Suction and Irrigation (cont.)

Standard Suction/Irrigation System

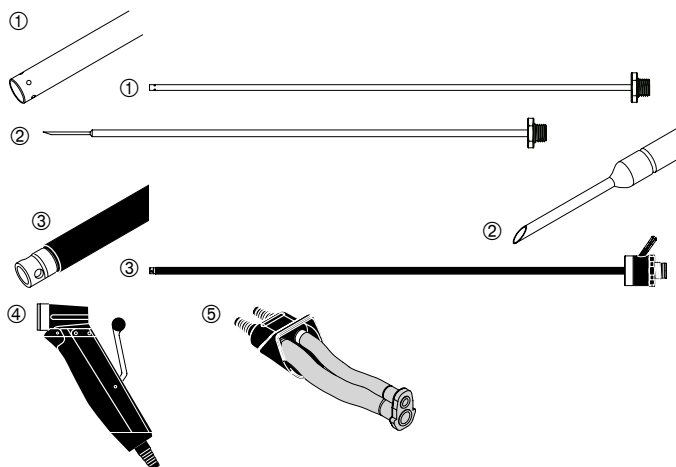

- | | | |
|---|-----------------|--|
| ① | WA51111A | Suction/irrigation tube, 3 x 360 mm, distal holes, for HiQ+ handle |
| | WA51131A | Suction/irrigation tube, 5 x 360 mm, distal holes, for HiQ+ handle |
| | WA51131L | Suction/irrigation tube, 5 x 450 mm, distal holes, for HiQ+ handle |
| ② | WA51132A | Suction/irrigation tube, 5 x 360 mm, for aspiration, for HiQ+ handle |
| ③ | WA51138A | Suction/irrigation tube, 5 x 360 mm, button, unipolar, for HiQ+ handle |
| ④ | WA51172A | Handle "HiQ+" (spare, not shown), for suction/irrigation tube, valve |
| ⑤ | WA51181S | Valve tubing (spare), for HiQ+ handle, suction channel 5 mm, 1 pc. |

Large Diameter Suction/Irrigation System

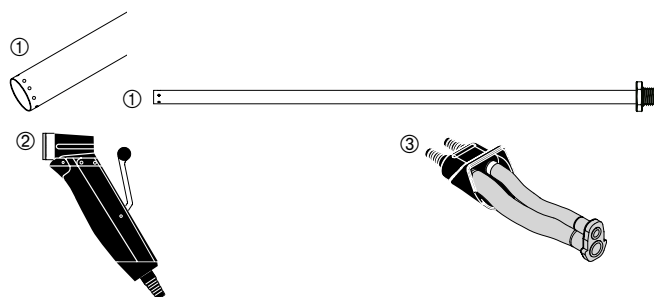

- | | | |
|---|-----------------|--|
| ① | WA51151A | Suction/irrigation tube, distal holes, for HiQ+ handle, 10 x 360 mm |
| | WA51151L | Suction/irrigation tube, distal holes, for HiQ+ handle, 10 x 450 mm |
| ② | WA51172A | Handle "HiQ+" (spare, not shown), for suction/irrigation tube, valve |
| ③ | WA51181L | Valve tubing (spare), for HiQ+ handle, suction channel 8 mm, 1 pc. |

Spare Parts

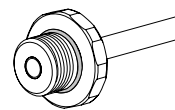

- | | |
|-----------------|--|
| WA51187A | Sealing ring, for HiQ+ suction/irrigation tube, 10 pcs., small |
| WA51188A | Sealing ring, for HiQ+ suction/irrigation tube, 10 pcs., large |

System Chart

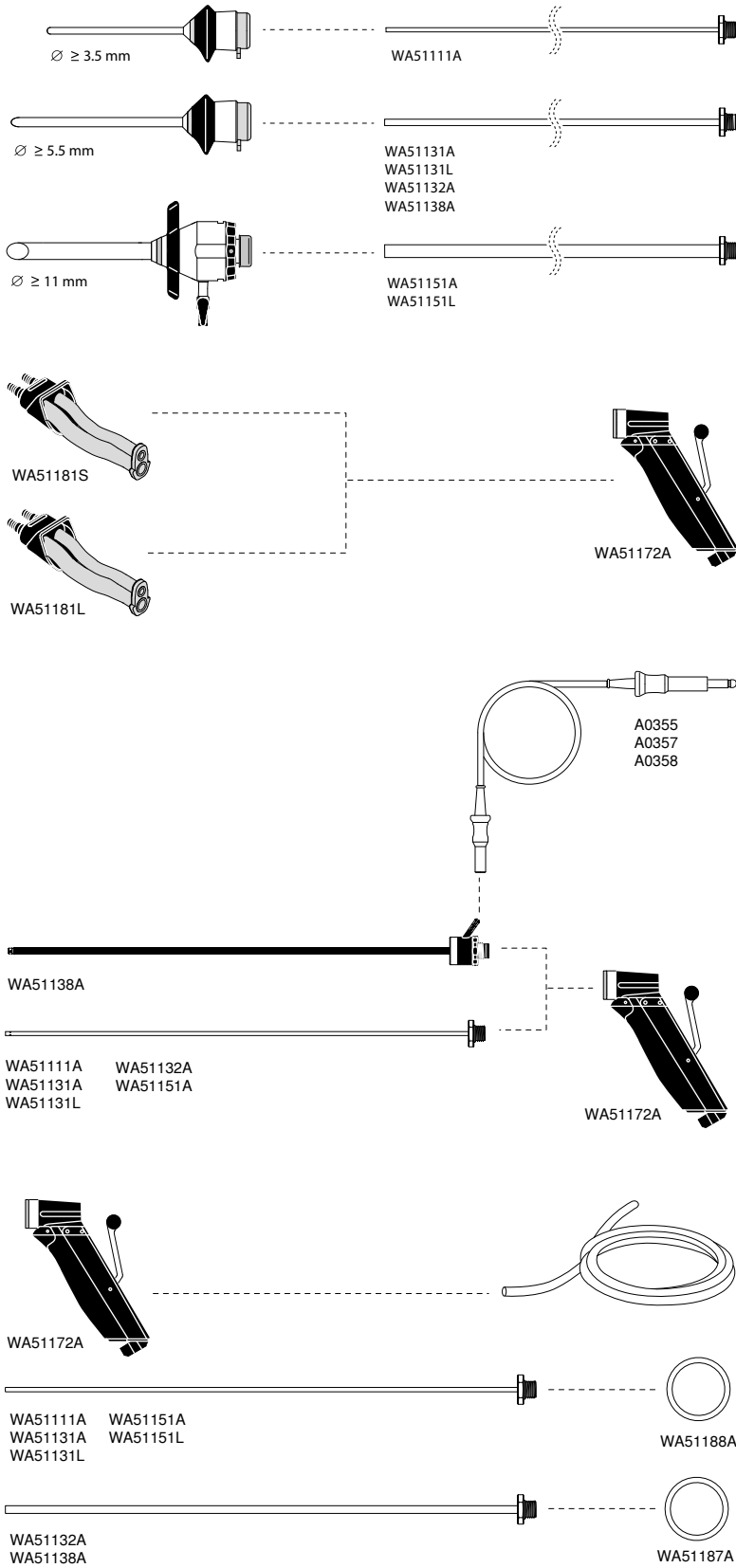

Surgery

Lavage

Instruments for Lavage

Modular Suction/Irrigation Instrument

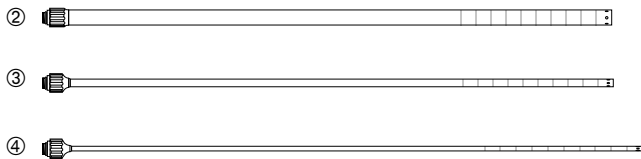
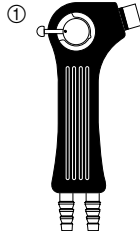

- | | | |
|---|--------------|--|
| ① | A5796 | Handle,
for suction/irrigation tube |
| ② | A5797 | Suction/irrigation tube,
10 mm, for A5796 |
| ③ | A5798 | Suction/irrigation tube,
5 mm, for A5796 |
| ④ | A5799 | Suction/irrigation tube,
3 mm, for A5796 |

Tubings

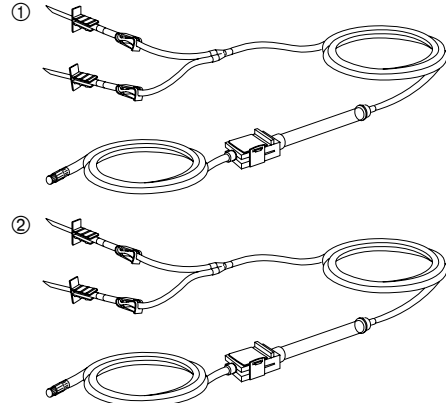

- | | | |
|---|--------------|---|
| ① | A4054 | Tubing, set, for 2 bags, for single use, 10 pcs.
▪ Sterile |
| ② | A4055 | Tubing, set, for 2 bags, 1 pc.
▪ Non-sterile, reusable |

HiQ+

HF Electrodes

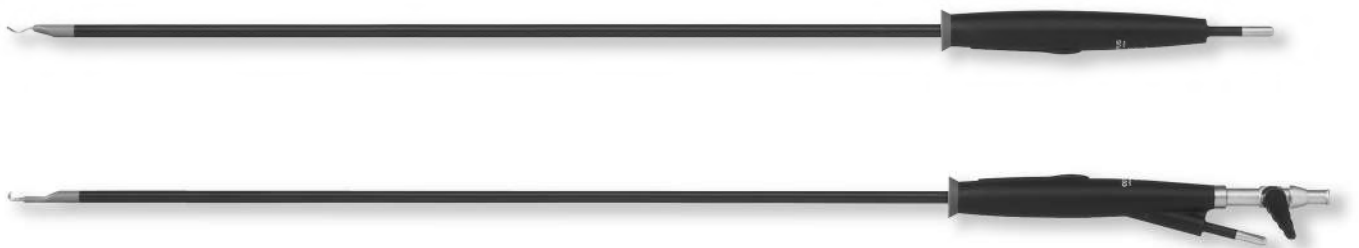

Surgery

**Baden-Württemberg
International Design Award 2004**



reddot design award
winner 2000



Design
Award
Winner
2000

- Ceramic tip
- With or without inline suction channel
- Ergonomic design
- Cost effective thanks to high durability
- UHI-4/UHI-3 addition for automatic suction

HiQ+ HF Electrodes

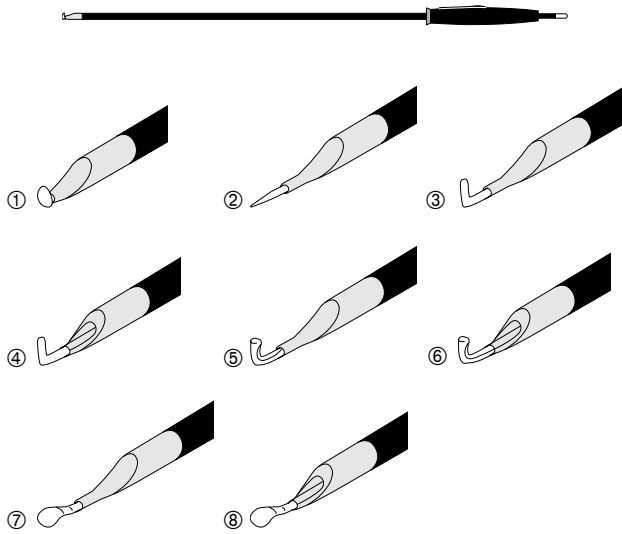

①	A6280	HF electrode, button, 5 x 330 mm
②	A6281	HF electrode, needle, 5 x 330 mm
③	A6282	HF electrode, hook, 5 x 330 mm
④	A6292	HF electrode, hook, with suction channel, 5 x 330 mm
⑤	A6283	HF electrode, hook long, 5 x 330 mm
	A6289	HF electrode, hook long, 5 x 400 mm
⑥	A6293	HF electrode, hook long, with suction channel, 5 x 330 mm
	A6299	HF electrode, hook long, with suction channel, 5 x 400 mm
⑦	A6284	HF electrode, spoon, 5 x 330 mm
⑧	A6294	HF electrode, spoon, with suction channel, 5 x 330 mm

With 4 mm HF pin.

HF Cables

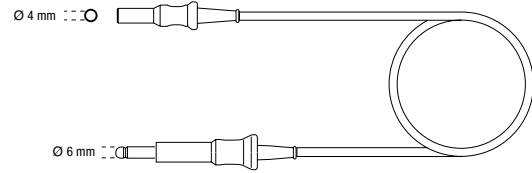

A0358	HF cable, monopolar Compatible HF units: <ul style="list-style-type: none"> ▪ ESG-400 ▪ ESG-410 ▪ Valleylab (new)
A0355	HF cable, monopolar Compatible HF units: <ul style="list-style-type: none"> ▪ Valleylab (old)
A0357	HF cable, monopolar Compatible HF units: <ul style="list-style-type: none"> ▪ ESG-400 ▪ ESG 410 ▪ Erbe T series ▪ Berchtold

Electrosurgical High Frequency Devices

Standard Mono- and Bipolar Energy



Surgery

The Olympus electrocautery portfolio offers a wide range of electrocautery instruments, for laparoscopic and open procedures, including disposable monopolar electrodes, pencils and suction coagulators, reusable bipolar forceps and a number of different accessories. Featuring a lightweight, ergonomic design and flexible cable, the Olympus electrocautery pencils are preloaded with high quality and economical nonstick (PTFE) or stainless steel blade electrodes. To serve multiple surgical needs, a variety of nonstick and stainless steel electrodes in different lengths and tip styles is available.



Portfolio compatible to ESG-400, ESG-410 and other standard high frequency generators.

Disposable Monopolar Electrosurgical Electrodes

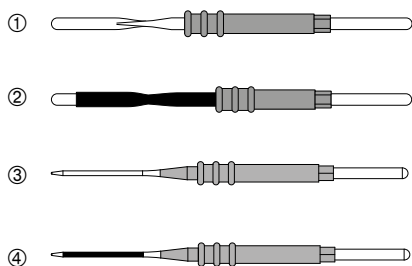

①	WA98510E	Electrode, Blade, 2.75", coated, 10 pcs./box
	WA98511E	Electrode, Blade, 2.75", non-coated, 10 pcs./box
	WA98530E	Electrode, Blade, 4", coated, 10 pcs./box
	WA98531E	Electrode, Blade, 4", non-coated, 10 pcs./box
	WA98550E	Electrode, Blade, 6", coated, 10 pcs./box
	WA98551E	Electrode, Blade, 6", non-coated, 10 pcs./box
②	WA98520E	Electrode, Blade, 2.75", coated, extended insulation, 10 pcs./box
	WA98521E	Electrode, Blade, 2.75", non-coated, extended insulation, 10 pcs./box
	WA98540E	Electrode, Blade, 4", coated, extended insulation, 10 pcs./box
	WA98541E	Electrode, Blade, 4", non-coated, extended insulation, 10 pcs./box
	WA98560E	Electrode, Blade, 6", coated, extended insulation, 10 pcs./box
	WA98561E	Electrode, Blade, 6", non-coated, extended insulation, 10 pcs./box
③	WA98610E	Electrode, Needle, 2.75", coated, 10 pcs./box
	WA98611E	Electrode, Needle, 2.75", non-coated, 10 pcs./box
	WA98630E	Electrode, Needle, 4", coated, 10 pcs./box
	WA98631E	Electrode, Needle, 4", non-coated, 10 pcs./box
	WA98650E	Electrode, Needle, 6", coated, 10 pcs./box
	WA98651E	Electrode, Needle, 6", non-coated, 10 pcs./box
④	WA98620E	Electrode, Needle, 2.75", coated, extended insulation, 10 pcs./box
	WA98640E	Electrode, Needle, 4", coated, extended insulation, 10 pcs./box
	WA98621E	Electrode, Needle, 2.75", non-coated, extended insulation, 10 pcs./box
	WA98641E	Electrode, Needle, 4", non-coated, extended insulation, 10 pcs./box
	WA98661E	Electrode, Needle, 6", non-coated, extended, 10 pcs./box
	WA98660E	Electrode, Needle, 6", coated, extended insulation, 10 pcs./box

Disposable Monopolar Electrosurgical Electrodes (cont.)

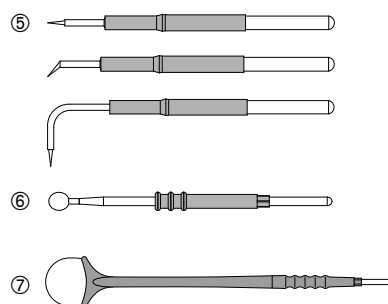

⑤	WA98710E	Electrode, Fine Needle, tungsten, 2", 10 pcs./box, (US only)
	WA98720E	Electrode, Fine Needle, tungsten, 2", 45 degree, 10 pcs./box, (US only)
	WA98730E	Electrode, Fine Needle, tungsten, 2.5", 10 pcs./box, (US only)
	WA98740E	Electrode, Fine Needle, tungsten, 2.5", 45 degree, 10 pcs./box, (US only)
	WA98750E	Electrode, Fine Needle, tungsten, 2.5", 90 degree, 10 pcs./box, (US only)
	WA98760E	Electrode, Fine Needle, tungsten, 4", 10 pcs./box, (US only)
	WA98770E	Electrode, Fine Needle, tungsten, 6", 10 pcs./box, (US only)
⑥	WA98830E	Electrode, Ball, 2", 5 mm, coated, 10 pcs./box
	WA98840E	Electrode, Ball, 2", 5 mm, non-coated, 10 pcs./box
	WA98810E	Electrode, Ball, 5", 5 mm, coated, 10 pcs./box
	WA98820E	Electrode, Ball, 5", 5 mm, non-coated, 10 pcs./box
⑦	WA98950E	Electrode, Loop, 10x10, 10 pcs./box
	WA98951E	Electrode, Loop, 15x10, 10 pcs./box
	WA98952E	Electrode, Loop, 20x10, 10 pcs./box
	WA98953E	Electrode, Loop, 20x15, 10 pcs./box

Sterile

Disposable Laparoscopic Electrosurgical Devices

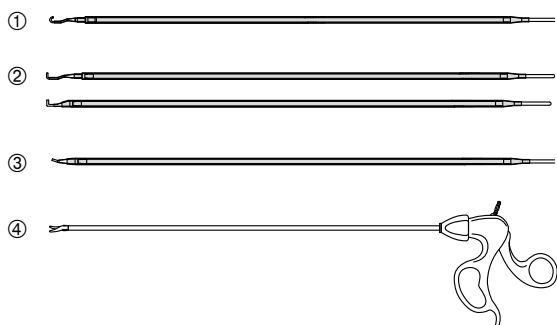

①	WA98910E	Electrode, Lap, J Hook, Wire, 33 cm, Disposable, coated, 10 pcs./box (US only)
	WA98911E	Electrode, Lap, J Hook, Wire, 33 cm, Disposable, non-coated, 10 pcs./box (US only)
	WA98915E	Electrode, Lap, J Hook, Wire, 45 cm, Disposable, coated, 10 pcs./box (US only)
	WA98916E	Electrode, Lap, J Hook, Wire, 45 cm, Disposable, non-coated, 10 pcs./box (US only)
②	WA98920E	Electrode, Lap, L Hook, Flat, 33 cm, Disposable, coated, 10 pcs./box (US only)
	WA98921E	Electrode, Lap, L Hook, Flat, 33 cm, Disposable, non-coated, 10 pcs./box (US only)
	WA98925E	Electrode, Lap, L Hook, Flat, 45 cm, Disposable, coated, 10 pcs./box (US only)
	WA98926E	Electrode, Lap, L Hook, Flat, 45 cm, Disposable, non-coated, 10 pcs./box (US only)
	WA98930E	Electrode, Lap, L Hook, Wire, 33 cm, Disposable, coated, 10 pcs./box (US only)
	WA98931E	Electrode, Lap, L Hook, Wire, 33 cm, Disposable, non-coated, 10 pcs./box (US only)
	WA98935E	Electrode, Lap, L Hook, Wire, 45 cm, Disposable, coated, 10 pcs./box (US only)
	WA98936E	Electrode, Lap, L Hook, Wire, 45 cm, Disposable, non-coated, 10 pcs./box (US only)
③	WA98940E	Electrode, Lap, Curved Spatula, 33 cm, Disposable, coated, 10 pcs./box (US only)
	WA98941E	Electrode, Lap, Curved Spatula, 33 cm, Disposable, non-coated, 10 pcs./box (US only)
	WA98945E	Electrode, Lap, Curved Spatula, 45 cm, Disposable, coated, 10 pcs./box (US only)
	WA98946E	Electrode, Lap, Curved Spatula, 45 cm, Disposable, non-coated, 10 pcs./box (US only)
④	WA98600A	LAP. Curved Scissors High Insulation, 33 cm, 1 pcs./box (US only)
	WA98700A	LAP. Curved Scissors High Insulation, 45 cm, 1 pcs./box (US only)

Sterile

Disposable Monopolar Electrosurgical Pencils

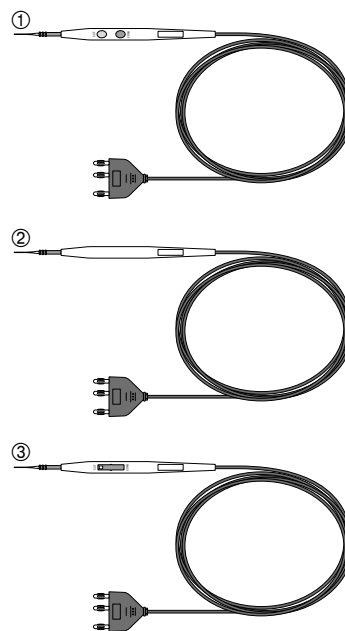

①	WA98210B	Electrosurgical pencil, 3 m cable, push button with coated blade, 50 pcs./box
	WA98211B	Electrosurgical pencil, 3 m cable, push button with non-coated blade, 50 pcs./box
	WA98220B	Electrosurgical pencil, 3 m cable, push button with coated blade, holster, 30 pcs./box
	WA98221B	Electrosurgical pencil, 3 m cable, push button with non-coated blade, holster, 30 pcs./box
	WA98230B	Electrosurgical pencil, 3 m cable, push button with coated high insulation blade, holster, 30 pcs./box
	WA98231B	Electrosurgical pencil, 4.5 m cable, push button with coated blade, 50 pcs./box
②	WA98210F	Electrosurgical pencil, 3 m cable, foot control with coated blade, 50 pcs./box
	WA98211F	Electrosurgical pencil, 3 m cable, foot control with non-coated blade, 50 pcs./box
	WA98220F	Electrosurgical pencil, 3 m cable, foot control with coated blade, holster, 30 pcs./box
	WA98221F	Electrosurgical pencil, 3 m cable, foot control with non-coated blade, holster, 30 pcs./box
③	WA98210R	Electrosurgical pencil, 3 m cable, rocker switch with coated blade, 50 pcs./box
	WA98211R	Electrosurgical pencil, 3 m cable, rocker switch with non-coated blade, 50 pcs./box
	WA98220R	Electrosurgical pencil, 3 m cable, rocker switch with coated blade, holster, 30 pcs./box
	WA98221R	Electrosurgical pencil, 3 m cable, rocker switch with non-coated blade, holster, 30 pcs./box
	WA98230R	Electrosurgical pencil, 3 m cable, rocker switch with coated high insulation blade, holster, 30 pcs./box
	WA98231R	Electrosurgical pencil, 4.5 m cable, rocker switch with coated blade, 50 pcs./box

Sterile

Disposable Smoke Evacuation

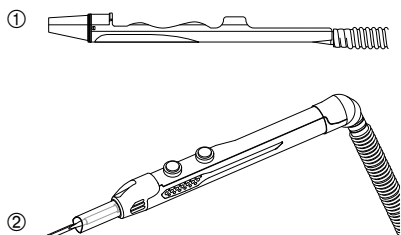

- ① **WA98192S** OR-VAC monopolar electrosurgical pencil adapter, 22 mm tubing, 20pcs./box
- ② **WA98191S** Integrated Smoke Evacuation Pencil, telescopic, with coated blade electrode, 22 mm tubing, push button with coated blade, 20pcs./box

For OR-VAC, see page 435.

Disposable Monopolar Suction Coagulators

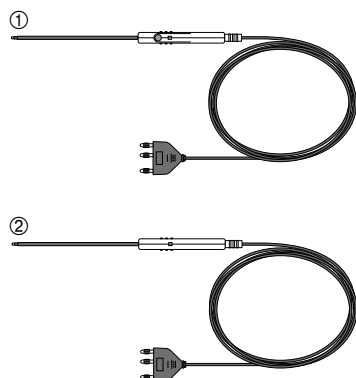

- ① **WA98410C** Suction coagulator, 8 Fr., hand switch, 15 pcs./box
- WA98420C** Suction coagulator, 10 Fr., hand switch, 15 pcs./box
- WA98430C** Suction coagulator, 12 Fr., hand switch, 15 pcs./box
- ② **WA98411C** Suction coagulator, 8 Fr. foot control, 15 pcs./box
- WA98421C** Suction coagulator, 10 Fr. foot control, 15 pcs./box
- WA98431C** Suction coagulator, 12 Fr. foot control, 15 pcs./box

Reusable Bipolar Forceps

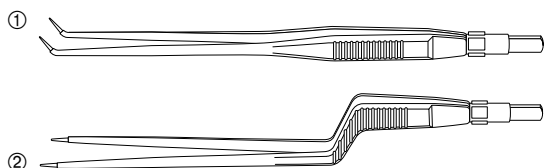

- ① **WB990038** Forceps 180 mm angled shaft, flexible blunt 2.0 mm, insul. flat-plug
- ② **WB990041** Bipolar Forceps 200 mm bayonet straight blunt 1.0 mm, insul. flat-plug

Bipolar Cable

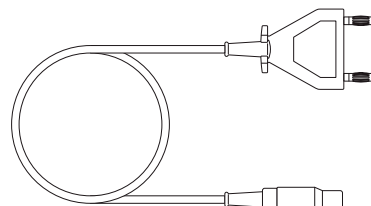

- WB990037** Bipolar cable 3 m, flat-plug, squared generator end: Valleylab-plug, reusable, non-sterile
- WA98500A** Bipolar forceps cable, fixed lead, sterile, disposable

Disposable Neutral Electrodes

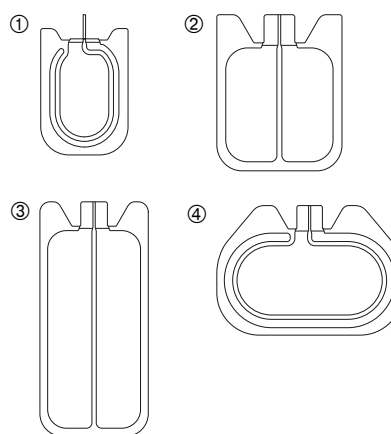

- ① **WA99512C** Neutral electrode, for newborns, with cable, 15 pcs./box
- ② **WA99513A** Neutral electrode, for children, without cable, 100 pcs./box
- WA99513C** Neutral electrode, for children, with cable, 15 pcs./box
- ③ **WA99514A** Neutral electrode, for adults, without cable, 100 pcs./box
- WA99514C** Neutral electrode, for adults, with cable, 15 pcs./box
- ④ **WA99516A** Neutral electrode, universal size, without cable, 100 pcs./box
- WA99516C** Neutral electrode, universal size, with cable, 15 pcs./box
- WA99510A** Cable, for neutral electrode, suitable for manual and automatic reprocessing and autoclaving, reuseable, 4.5 m, 1 pc./box

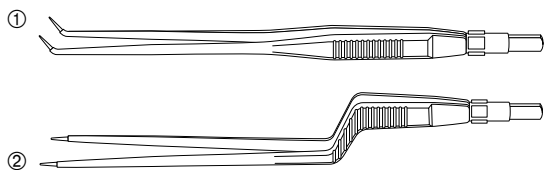
Reusable Bipolar Electrosurgical Devices

- ① **WB990038** Bipolar forceps angled, 180 mm, 1 pc./box
- ② **WB990041** Bipolar forceps bayonet, 200 mm, 1 pc./box

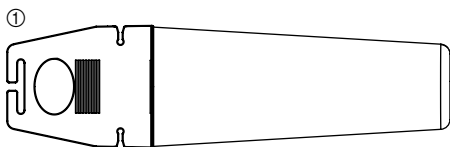
Disposable Accessories

- ① **WA98300A** Holster, non-sterile, 12 pcs./box
- WA98200A** Tip cleaner, 48 x 48 mm, 50 pcs./box (not shown)

- ☒ For ESG-400, see page 547.
- ☒ For ESG-410, see page 549.
- ☒ For ESG-300, see page 541.
- ☒ For Energy Cart TC-E410, see page 557.